

4000® SERIES RACEWAY



Single- and Dual-Channel, Steel Raceway. Easy-to-install and ideal for basic power or communication/low voltage installations.

CODE REFERENCE

cULus Listed Raceway:
File E4376 Guide RJBT.

Fittings:
File E41751 Guide RJPR.
Meets Article 386 of NEC.
Meets Section 12-1600 of CEC.

System Layout

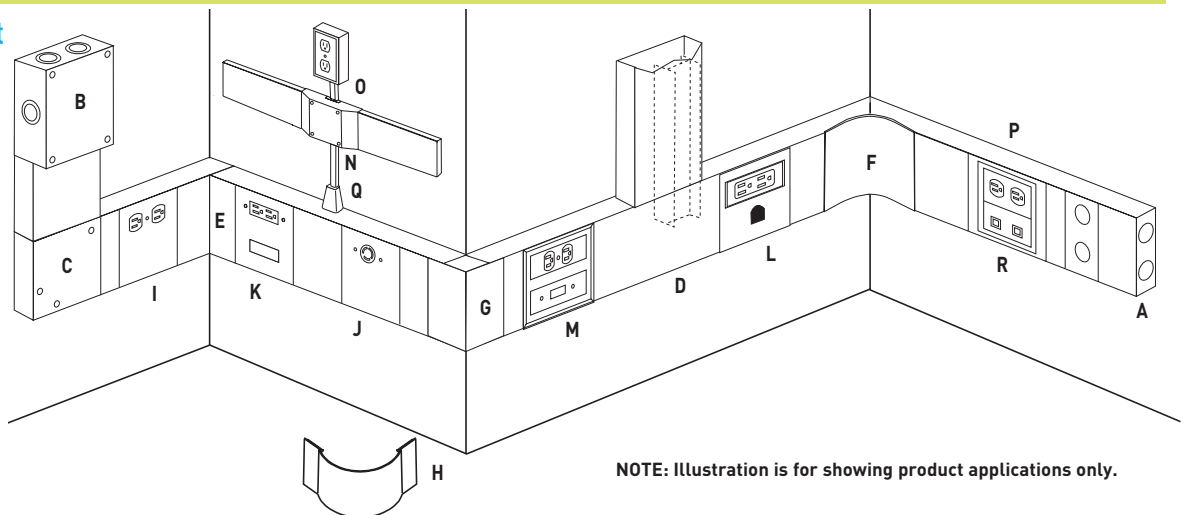

NOTE: Illustration is for showing product applications only.

KEY

- | | | | |
|---|---|--|--|
| A. 4010B Blank End Fitting | G. 4018 External Elbow | K. 4047RF Rectangular Receptacles and Modular Furniture Device Plate | N. 4075DA Bridge Fitting |
| B. 4010DFO Entrance End Fitting | H. 4018FO Radiused Full Capacity External Elbow | L. 4047RH Device Plate for Rectangular Receptacle and Mousehole | O. 500 Series Raceway |
| C. 4011 Flat Elbow | I. 4047BX Duplex Receptacle Device Plate | M. 4050 Device Mounting Plate with 5507 Series Faceplates | P. 5507D Duplex Faceplate |
| D. 4015D Divided Tee | J. 4047JX Single Receptacle & Device Plate | | Q. 5785 Combination Connector |
| E. 4017 Internal Elbow | | | R. 5507RJ Device Plate with two RJ ports |
| F. 4017FO Radiused Full Capacity Internal Elbow | | | |

COLOR OPTIONS



4000® Series Raceway Part Numbers with a "V" prefix have an ivory finish. Part Numbers with a "G" prefix have a gray finish.

Custom color options are also available. Consult the factory for more information.

4000[®] SERIES RACEWAY

4000 Series Raceway Ordering Information (continued)

4001DA Divider Clip (Galvanized)

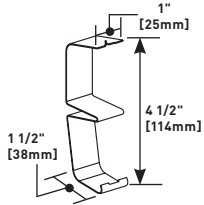

Required for holding G4000D Divider in place. Use one every 2 1/2' [.762m].

V4011FO, G4011FO Radiused Full Capacity Flat Elbow

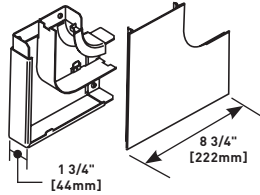

Full capacity 90° flat corner used in divided or undivided applications. 2" [51mm] bend radius control for UTP, STP and fiber optic installations. Ideal for new installations when the cable is lay-in or pull-through.

V4006, G4006 Seam Clip

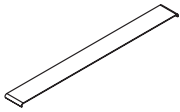

Covers seams where two sections of 4000 Series Raceway covers come together.

V4012TX, G4012TX Internal or External 45° Elbow

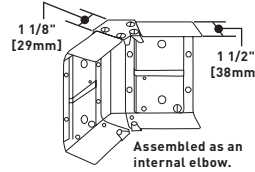

Internal or external 45° turns in a run of 4000 Series Raceway. Can also be assembled as an inverted 45° elbow.



V4010B, G4010B Blank End Fitting

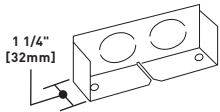

Closes off open end of 4000 Series Raceway. Has two 1/2" trade size KOs to facilitate end feeding.

V4014A, G4014A Wall Box Connector

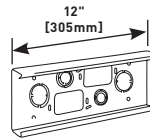

Base has two concentric 1", 3/4", and 1/2" trade size KOs, two concentric 1 1/4", and 1" KOs (undivided only), and two rectangular 2 9/16" x 1 11/16" KOs.

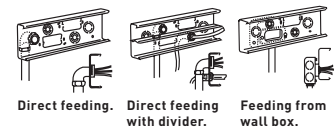

V4010DFO, G4010DFO Entrance End Fitting

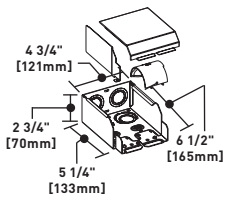

Full capacity entrance end fitting. Has concentric 3/4", 1", and 1 1/4" trade size KOs on end and bottom for feeding 4000 Series Raceway. Includes removable divider and 1 1/4" [32mm] bend radius control insert for UTP/STP and fiber optic cable installations.

V4015, G4015 Tee

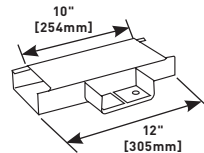

For branching raceway at right angles. Use with undivided raceway only. Join to raceway run with two pair of 4001A Couplings (not included).

V4011, G4011 Flat Elbow

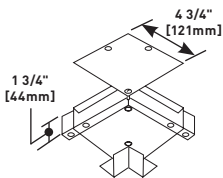

Right angle turns on the same surface.

V4015D, G4015D Divided Tee

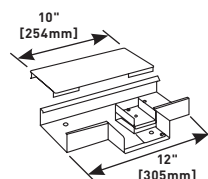

For branching raceway at right angles. Use with divided raceway only. Join to raceway run with two pair of 4001A Couplings (not included).