

2400D[®] SERIES RACEWAY



Dual channel version of 2400 Series Raceway. Easy-to-install and ideal for basic power and communication/low voltage installations in classrooms, hotels, and anywhere a low profile raceway solution is needed.

CODE REFERENCE

cULus Listed Raceway:
File E4376 Guide RJBT.

Fittings:
File E41751 Guide RJPR.
Meets Article 386 of NEC.
Meets Section 12-1600 of CEC.

2400D Series Raceway System Layout for Power & Data

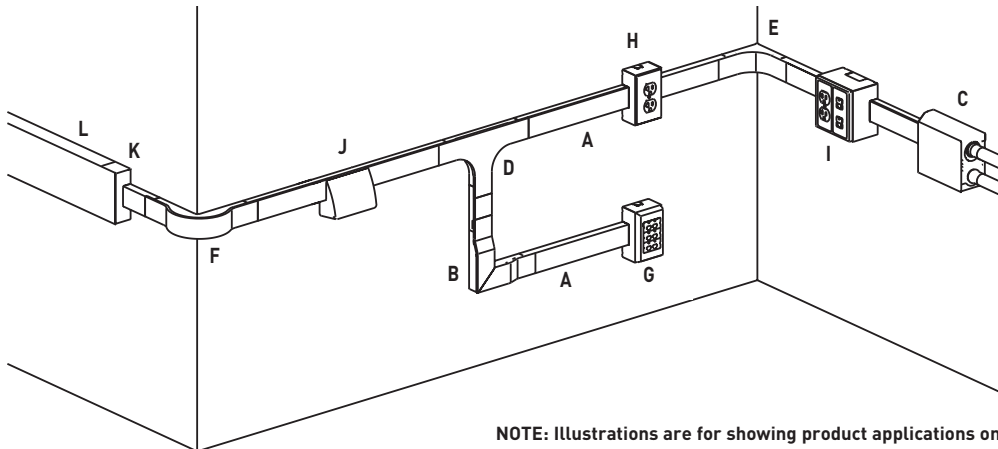

NOTE: Illustrations are for showing product applications only.

KEY

- | | |
|--|--|
| A. 2400D 2400 Series Divided Raceway | H. 2444D One-Gang Device Box |
| B. 2411DFO Radiused Divided Flat Elbow | I. 2444D-2A Two-Gang Divided Device Box |
| C. 2410DFO Divided Entrance End Fitting | J. 24DWND Downward Duplex Device Bracket |
| D. 2415DFO Radiused Divided Tee | 24DWNR Downward Decorator Device Bracket |
| E. 2417DFO Radiused Divided Internal Elbow | K. 4089 Reducing Connector |
| F. 2418DFO Divided External Elbow | L. U4000 Series Raceway |
| G. 2444 One-Gang Extra Deep Device Box | |

COLOR OPTIONS



2400 Series™ Raceway Part Numbers with a "V" prefix have an ivory finish. Part Numbers with a "-FW" suffix have a fog white finish.

Custom color options are also available. Consult the factory for more information.

2400D SERIES™ RACEWAY

2400D Series Raceway Fittings Ordering Information (continued)

V2475D, 2475D-FW Bridge Fitting

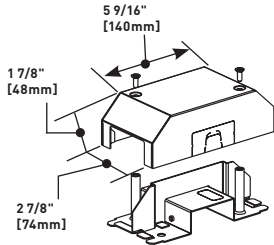

Allows 2400D Series Raceway runs to bridge over existing installations of 2400, 2400D, 500, and 700 Series Raceways.

IWE-S, DVWE-S Spray Paint



Used for touching up large areas. Contains 12 oz. of paint. Available in ivory (IWE-S) and fog white (DVWE-S).

NOTE: Can only be shipped via ground transportation

V4089 Reducing Connector

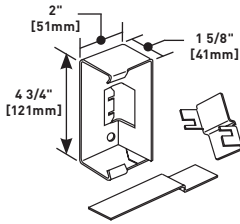

Connects 4000 Series Raceway to 2400D Series Raceway.

IWE-P, DVWE-P Touch-Up Paint Pen



Used for touching up small areas. Contains 0.3 oz. of paint. Available in ivory (IWE-P) and fog white (DVWE-P).

5507 Series Faceplates Ordering Information

5507AD, 5507AD-FW Modular Furniture Adapter

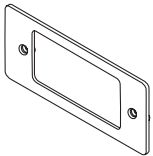

Covers Activate modular furniture adapter and other modular furniture adapters. Not for use with decorator (rectangular) style devices.

5507R, 5507R-FW Rectangular Faceplate

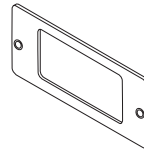

Covers rectangular decorator style devices.

5507B, 5507B-FW Blank Faceplate

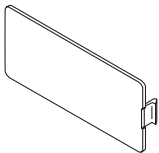

Covers unused compartments in the device bracket.

5507SW, 5507SW-FW Switch Faceplate

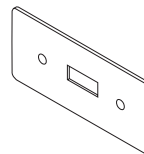

Covers standard toggle switches.

5507D, 5507D-FW Duplex Faceplate

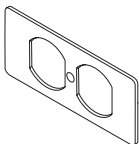

Covers duplex style devices including 106 Frame.

5507T1, 5507T1-FW Single Receptacle Faceplate

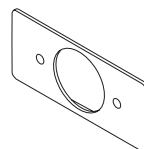

Covers single receptacles 1.59" [40.4mm] diameter.

5507 SERIES™ FACEPLATES

Ordering Information

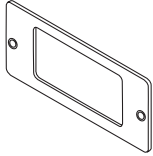
5507R Rectangular Receptacle Faceplate

For covering rectangular decorator style devices. Available in ivory (5507R), white (5507R-WH), gray (5507R-G) and fog white (5507R-FW).

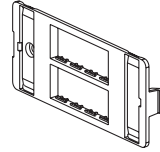
5507-4TJ Ortronics® Faceplate

For mounting Ortronics® datacom inserts. Accepts four TracJack devices. Available in ivory (5507-4TJ), white (5507-4TJ-WH), gray (5507-4TJ-G) and fog white (5507-4TJ-FW).

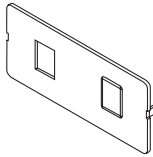
5507RJ Dual RJ11/RJ45 Connector Faceplate

For mounting one or two keystone device modules. Has one opening and one KO. Available in ivory (5507RJ), white (5507RJ-WH), gray (5507RJ-G), light gray (5507RJ-GY) and fog white (5507RJ-FW).

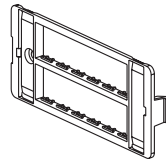
5507-6TJ Ortronics® Faceplate

For mounting Ortronics® datacom inserts. Accepts six TracJack devices. Available in ivory (5507-6TJ), white (5507-6TJ-WH), gray (5507-6TJ-G) and fog white (5507-6TJ-FW).

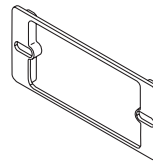
5507S Rectangular Spacer

For mounting commercial device plates. Installs between the device bracket and a device. Available in ivory (5507S), white (5507S-WH), black (5507S-BK), fog white (5507S-FW), light gray (5507S-GY) and gray (5507S-G).

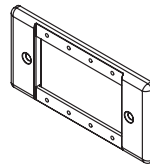
5507MAAP Extron® MAAP Faceplate

Accepts four AVIP and Extron® Electronics MAAP single space modules. Available in ivory (5507MAAP), white (5507MAAP-WH), gray (5507MAAP-G), black (5507MAAP-BK), light gray (5507MAAP-GY) and fog white (5507MAAP-FW).

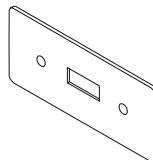
5507SW Switch Faceplate

For covering standard toggle switches. Available in ivory (5507SW), white (5507SW-WH), gray (5507SW-G) and fog white (5507SW-FW).

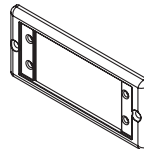
5507AAP Extron® AAP Faceplate

Accepts two Extron® Electronics AAP single space modules. Available in ivory (5507AAP), white (5507AAP-WH), gray (5507AAP-G), black (5507AAP-BK), light gray (5507AAP-GY) and fog white (5507AAP-FW).

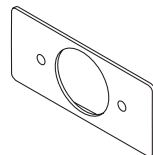
5507T1 Single Receptacle Faceplate

For covering single receptacles 1.59" [40mm] diameter. Available in ivory (5507T1), white (5507T1-WH), gray (5507T1-G) and fog white (5507T1-FW).

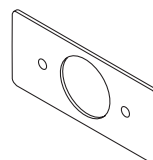
5507T2 Single Receptacle Faceplate

For covering single receptacles 1.41" [36mm] diameter. Available in ivory (5507T2), white (5507T2-WH), gray (5507T2-G) and fog white (5507T2-FW).

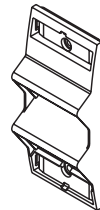
ARA-S2 Angled Raceway Adapter

Provides angled exit in multi-channel raceway systems. Snaps into standard 4050, 5450, 5450T, 5550, 40N2F31 and WallSource Device Brackets. Angled exit provides additional mounting depth required for A/V connections as well as ensuring the required bend radius for UTP and fiber optic cabling. Holds two Ortronics® Series II modules. Fits 5507 Series Faceplate opening. Available in ivory (ARA-S2-IV), fog white (ARA-S2-FW), black (ARA-S2-BK), gray (ARA-S2-G), light gray (ARA-S2-GY) and white (ARA-S2-WH).