

2400 SERIES™ RACEWAY



Single Channel Raceway . Easy-to-install and ideal for basic power or communication/low voltage installations in classrooms, hotels, and anywhere a low profile raceway solution is needed.

CODE REFERENCE

cULus Listed Raceway:
File E4376 Guide RJBT.

Fittings:
File E41751 Guide RJPR.
Meets Article 386 of NEC.
Meets Section 12-1600 of CEC.

2400 Series Raceway System Layout for Power

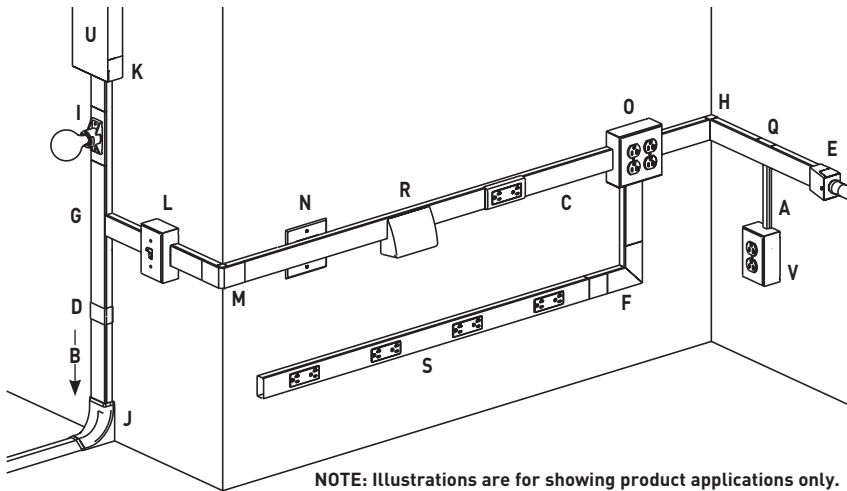

NOTE: Illustrations are for showing product applications only.

2400 Series Raceway System Layout for Communications

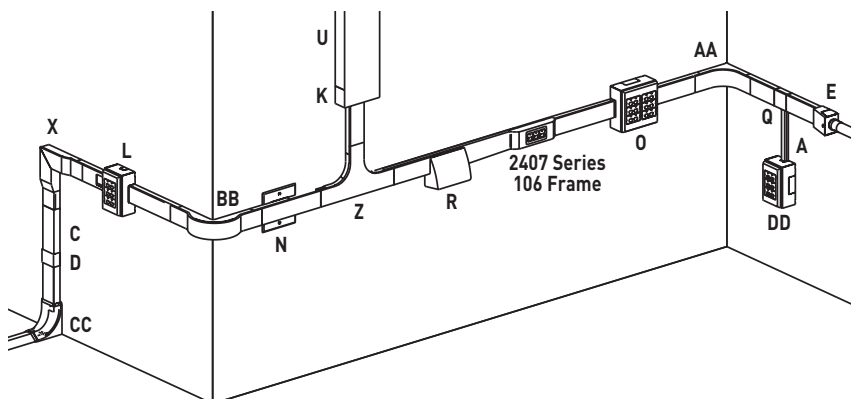

KEY

- A. 500 Series Raceway
- B. 1500/2600 Raceway Feed
- C. 2400 Series Raceway
- D. 2406 Cover Clip
- E. 2410C Entrance End Fitting
- F. 2411M Flat Elbow Fitting
- G. 2415M Tee Fitting
- H. 2417M Internal Elbow Fitting
- I. 2426 Lamp Holder
- J. 2686FO Transition Fitting
- K. 4089 Reducing Connector
- L. 2448 One-Gang Device Box
- M. 2418M External Elbow Fitting
- N. 2451H Back Feed Fitting
- O. 2448-2 Two-Gang Device Box
- P. 2475D Bridge Fitting
- Q. 2489 Reducing Adapter
- R. 24DWND Downward Duplex Device Bracket
24DWNR Downward Decorator Device Bracket
- S. 24S7218GBX99IV 2400 Series Plugmold Strip
- U. U4000 Series Raceway
- V. 5747 Shallow Switch Box
- W. 2400BC 2400 Series Raceway
- X. 2411FO Radiused Flat Elbow
- Y. 2415H Back Feed Fitting
- Z. 2415FO Radiused Tee Fitting
- AA. 2417FO Radiused Internal Elbow
- BB. 2418FO Radiused External Elbow
- CC. 2686FO Transition Feed Fitting
- DD. 5744 Extra Deep Device Box

COLOR OPTIONS



2400 Series™ Raceway Part Numbers with a "V" prefix have an ivory finish. Part Numbers with a "-FW" suffix have a fog white finish.

Custom color options are also available. Consult the factory for more information.

2400 SERIES™ RACEWAY

2400 Series Raceway Wire Fill Capacities for Communications

	CABLE/WIRE SIZE	O.D. (APPROX. DIA.)		40% FILL
		Inches	[mm]	
UNSHIELDED TWISTED PAIR	4-pair, 24 AWG, Cat 3	0.190	[4.8]	19
	4-pair, 24 AWG, Cat 5e	0.210	[5.3]	16
	4-pair, 24 AWG, Cat 6	0.250	[6.3]	11
	4-pair, 24 AWG, Cat 6a*	0.354	[9.0]	5
	25-pair, 24 AWG	0.410	[10.4]	4
COAXIAL	RG6/U	0.270	[6.9]	9
FIBER	ZipCord	0.118 x 0.236	[3 x 6]	20
	Round 4 Strand Fiber	0.187	[4.8]	20
	Round 6 Strand Fiber	0.256	[6.5]	10

2000 Series Raceway Wire Fill Capacities For Power

WIRE SIZE	O.D.		NO. OF CONDUCTORS (40%)	
	Inches	[mm]	WITHOUT DEVICES	WITH 2427 RECEPTACLE
THHN/THWN				
14 AWG	0.111	[2.8]	57	12
12 AWG	0.130	[3.3]	41	9
10 AWG	0.164	[4.2]	26	0

NOTE: For additional information, refer to the Technical Section.

* Category 6 augmented (6a) cable for 10 gigabit ethernetmax allowed cable diameter per addenda No. 11 ANSI TIA/EIA 568-B.2.

2400 Series Raceways Ordering Information

V2400B, V2400B-10, 2400B-FW, 2400B-10FW Raceway Base

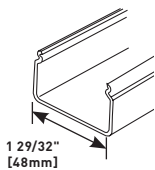

.040" [1.0mm] steel, 5' [1.5m] lengths. Packed twenty 5' [1.5m] lengths per carton (V2400B, 2400B-FW) or ten 10' [3m] lengths per carton (V2400B-10, 2400B-10FW).

V2400BC, 2400BC-FW Raceway Base & Cover

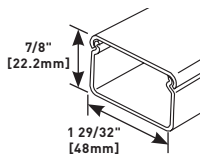

.040" [1.0mm] steel. Packed ten 5' [1.5m] lengths of base and cover per carton.

V2400C, 2400C-FW Raceway Cover

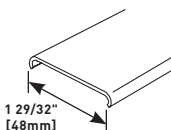

.040" [1.0mm] steel; packed twenty 5' [1.5m] lengths per carton.

624 2400 Series Raceway Base & Cover Cutter

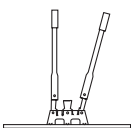

Portable cutter for 2400 & 2400D Series Raceway Base and Cover. Provides a clean and easy square cut every time.

624BCK Replacement Blade Kit

Case hard steel replacement blades and die set for 624 Cutter.

2400 Series Raceway Fittings Ordering Information

2400WC Wire Clip

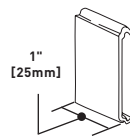

Additional support for conductors. (Nonmetallic)

2401 Coupling

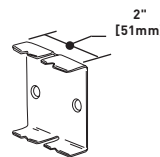

Joins lengths of 2400B Base together.

V2406, 2406-FW Cover Clip

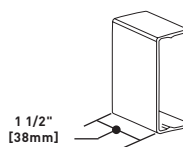

Covers seams where two lengths of 2400 Series Raceway come together (nonmetallic).

2409 Ground Clamp

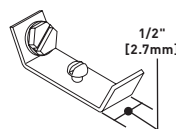

Connects equipment grounding conductor to provide ground to 2400 Series Raceway. No. 10 ground screw provided.

V2410A, 2410A-FW Entrance End Fitting

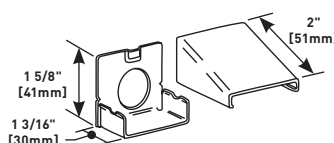

Connects 2400 Series Raceway with 1/2" trade size conduit or armored cable.

2400D SERIES™ RACEWAY

2400D Series Raceway Wire Fill Capacities for Communications

	CABLE/ WIRE SIZE	O.D. (APPROX. DIA.)		1/3 COMP 40% FILL	2/3 COMP 40% FILL
		Inches	[mm]		
UNSHIELDED TWISTED PAIR	4-pair, 24 AWG, Cat 3	0.190	[4.8]	5	12
	4-pair, 24 AWG, Cat 5e	0.210	[5.3]	4	9
	4-pair, 24 AWG, Cat 6	0.250	[6.3]	3	7
	4-pair, 24 AWG, Cat 6a*	0.354	[9.0]	1	3
	25-pair, 24 AWG	0.410	[10.4]	1	2
COAXIAL	RG6/U	0.270	[6.9]	2	6
Fiber	ZipCord	0.118 x 0.236	[3 x 6]	5	12
	Round 4 Strand Fiber	0.187	[4.8]	5	12
	Round 6 Strand Fiber	0.256	[6.5]	2	6

2400D Series Raceway Wire Fill Capacities for Power

WIRE SIZE	O.D.		NUMBER OF CONDUCTORS (40%)	
	Inches	[mm]	1/3 COMP	2/3 COMP
THHN/THWN 14 AWG	0.111	[2.8]	11	26
12 AWG	0.130	[3.3]	9	19
10 AWG	0.164	[4.2]	6	11

NOTE: For additional information, refer to the Technical Section.

* Category 6 augmented (6a) cable for 10 gigabit ethernet – max allowed cable diameter per addenda No. 11 ANSI TIA/EIA 568-B.2.

2400D Series Raceway Ordering Information

V2400BD, 2400BD-FW Divided Raceway Base

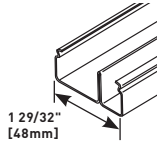

.040" [1.0mm] steel. Divided into two compartments (1/3 and 2/3 capacity). Packed ten 10' [3.0m] lengths per carton.

624BCK Replacement Blade Kit

Case hard steel replacement blades and die set for 624 Cutter.

V2400C, 2400C-FW Raceway Cover

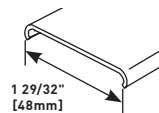

.040" [1.0mm] steel. Packed twenty 5' [1.5m] lengths per carton.

IWE-S, DVWE-S Spray Paint



Used for touching up large areas. Contains 12 oz. of paint. Available in ivory (IWE-S) and fog white (DVWE-S).

NOTE: Can only be shipped via ground transportation

624 2400 Series Raceway Base & Cover Cutter

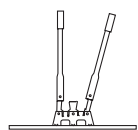

Portable cutter for 2400 & 2400D Series Raceway Base and Cover. Provides a clean and easy, square cut every time.

IWE-P, DVWE-P Touch-Up Paint Pen



Used for touching up small areas. Contains 0.3 oz. of paint. Available in ivory (IWE-P) and fog white (DVWE-P).

2400D Series Raceway Fittings Ordering Information

2400WC Wire Clip

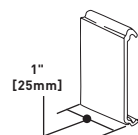

Additional support for conductors (nonmetallic).

2401D Divided Coupling

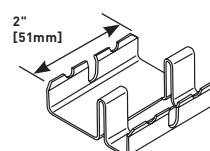

Joins lengths of 2400BD Divided Base.

PLUGMOLD® 2400 SERIES™

Plugmold 2400 Series Ordering Information

V2400BC Base and Cover

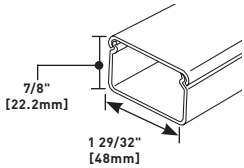

V2400B Base: .040" [1.0mm] steel; V2400C Cover: .025" [.6mm] steel. Packed ten 5' [1.5m] lengths of each per carton.

V2406 Cover Clip

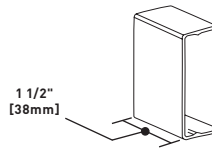

Covers seam where lengths of cover or base meet. Use with Plugmold® 2400 Series. (Nonmetallic.)

V2400B Raceway Base

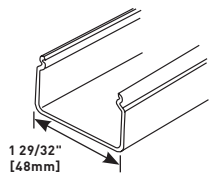

.040" [1.0mm] steel. Packed twenty 5' [1.5m] lengths per carton.

2409 Ground Clamp

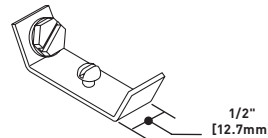

No. 10 ground screw provided. Use with Plugmold® 2400 Series.

V2400C Raceway Cover

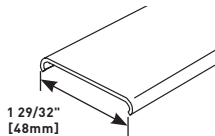

.040" [1.0mm] steel 5' [1.5m] lengths. Packed (20) 5' [1.5m] lengths per carton. V2400C Cover has no receptacle hole cuts.

V2410A Entrance End Fitting

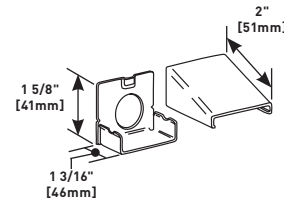

Connects Plugmold® 2400 Series with 1/2" trade size conduit and armored cable.

PM48T Multiple Outlet Strip (Diamond Plate Finish)

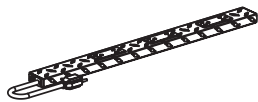

Diamond plate finish base .040" [1.0mm] steel. Cover .040" [1.0mm] steel. 48" [1.2m] length. Provides five duplex 15A receptacles. Packed three per carton. PM48T Merchandiser available – 10 cartons of PM48T packed in a merchandising display. Order as PM48T-DISP.

V2410B Blank End Fitting

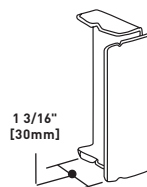

Closes off open end of Plugmold® 2400 Series.

2400WC Wire Clip

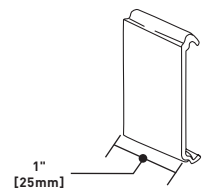

Holds conductors in place in raceway.

V2410C Entrance End Fitting

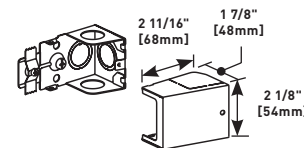

Has 1/2" and 3/4" trade size KOs on end and bottom. Additional 1/2" trade size KO on sides.

2401 Coupling

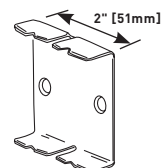

Joins lengths of raceway. Use with Plugmold® 2400 Series.