

2400 SERIES™ RACEWAY



Single Channel Raceway . Easy-to-install and ideal for basic power or communication/low voltage installations in classrooms, hotels, and anywhere a low profile raceway solution is needed.

CODE REFERENCE

cULus Listed Raceway:
File E4376 Guide RJBT.

Fittings:
File E41751 Guide RJPR.
Meets Article 386 of NEC.
Meets Section 12-1600 of CEC.

2400 Series Raceway System Layout for Power

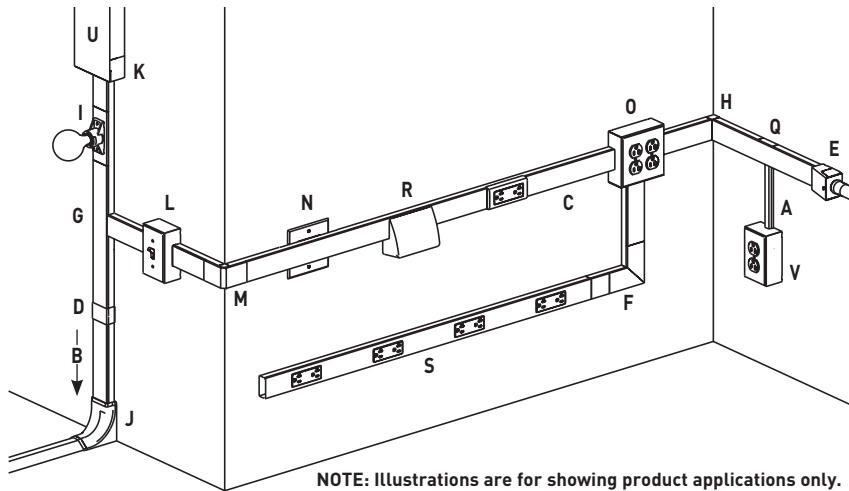

NOTE: Illustrations are for showing product applications only.

KEY

- A. 500 Series Raceway
- B. 1500/2600 Raceway Feed
- C. 2400 Series Raceway
- D. 2406 Cover Clip
- E. 2410C Entrance End Fitting
- F. 2411M Flat Elbow Fitting
- G. 2415M Tee Fitting
- H. 2417M Internal Elbow Fitting
- I. 2426 Lamp Holder
- J. 2686FO Transition Fitting
- K. 4089 Reducing Connector
- L. 2448 One-Gang Device Box
- M. 2418M External Elbow Fitting
- N. 2451H Back Feed Fitting
- O. 2448-2 Two-Gang Device Box
- P. 2475D Bridge Fitting
- Q. 2489 Reducing Adapter
- R. 24DWND Downward Duplex Device Bracket
24DWNR Downward Decorator Device Bracket
- S. 24S7218GBX99IV 2400 Series Plugmold Strip
- U. U4000 Series Raceway
- V. 5747 Shallow Switch Box
- W. 2400BC 2400 Series Raceway
- X. 2411FO Radiused Flat Elbow
- Y. 2415H Back Feed Fitting
- Z. 2415FO Radiused Tee Fitting
- AA. 2417FO Radiused Internal Elbow
- BB. 2418FO Radiused External Elbow
- CC. 2686FO Transition Feed Fitting
- DD. 5744 Extra Deep Device Box

2400 Series Raceway System Layout for Communications

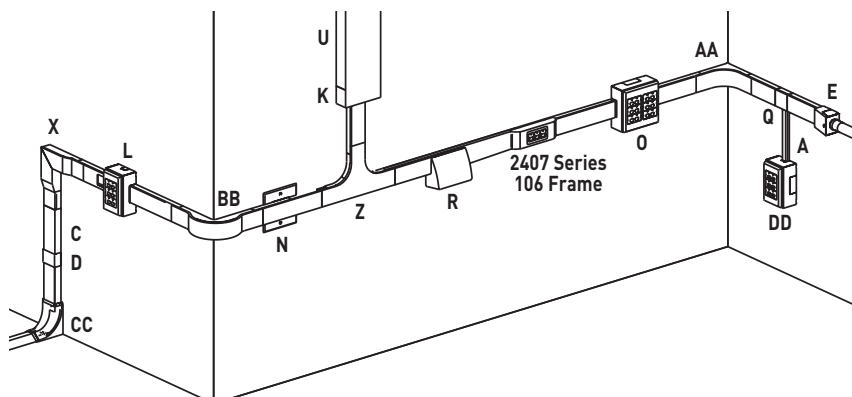

COLOR OPTIONS



2400 Series™ Raceway Part Numbers with a "V" prefix have an ivory finish. Part Numbers with a "-FW" suffix have a fog white finish.

Custom color options are also available. Consult the factory for more information.

2400 SERIES™ RACEWAY

2400 Series Raceway Wire Fill Capacities for Communications

	CABLE/WIRE SIZE	O.D. (APPROX. DIA.)		40% FILL
		Inches	[mm]	
UNSHIELDED TWISTED PAIR	4-pair, 24 AWG, Cat 3	0.190	[4.8]	19
	4-pair, 24 AWG, Cat 5e	0.210	[5.3]	16
	4-pair, 24 AWG, Cat 6	0.250	[6.3]	11
	4-pair, 24 AWG, Cat 6a*	0.354	[9.0]	5
	25-pair, 24 AWG	0.410	[10.4]	4
COAXIAL	RG6/U	0.270	[6.9]	9
FIBER	ZipCord	0.118 x 0.236	[3 x 6]	20
	Round 4 Strand Fiber	0.187	[4.8]	20
	Round 6 Strand Fiber	0.256	[6.5]	10

2000 Series Raceway Wire Fill Capacities For Power

WIRE SIZE	O.D.		NO. OF CONDUCTORS (40%)	
	Inches	[mm]	WITHOUT DEVICES	WITH 2427 RECEPTACLE
THHN/THWN				
14 AWG	0.111	[2.8]	57	12
12 AWG	0.130	[3.3]	41	9
10 AWG	0.164	[4.2]	26	0

NOTE: For additional information, refer to the Technical Section.

* Category 6 augmented (6a) cable for 10 gigabit ethernetmax allowed cable diameter per addenda No. 11 ANSI TIA/EIA 568-B.2.

2400 Series Raceway Fittings Ordering Information

2400WC Wire Clip

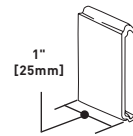

Additional support for conductors. (Nonmetallic)

2400 Series Raceways Ordering Information

V2400B, V2400B-10, 2400B-FW, 2400B-10FW Raceway Base

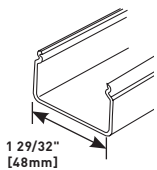

.040" [1.0mm] steel, 5' [1.5m] lengths. Packed twenty 5' [1.5m] lengths per carton (V2400B, 2400B-FW) or ten 10' [3m] lengths per carton (V2400B-10, 2400B-10FW).

2401 Coupling

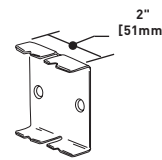

Joins lengths of 2400B Base together.

V2400BC, 2400BC-FW Raceway Base & Cover

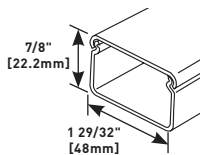

.040" [1.0mm] steel. Packed ten 5' [1.5m] lengths of base and cover per carton.

V2406, 2406-FW Cover Clip

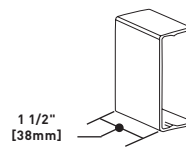

Covers seams where two lengths of 2400 Series Raceway come together (nonmetallic).

V2400C, 2400C-FW Raceway Cover

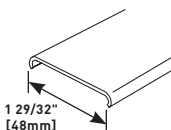

.040" [1.0mm] steel; packed twenty 5' [1.5m] lengths per carton.

2409 Ground Clamp

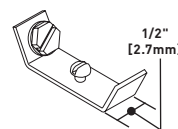

Connects equipment grounding conductor to provide ground to 2400 Series Raceway. No. 10 ground screw provided.

624 2400 Series Raceway Base & Cover Cutter

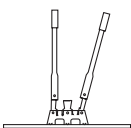

Portable cutter for 2400 & 2400D Series Raceway Base and Cover. Provides a clean and easy square cut every time.

V2410A, 2410A-FW Entrance End Fitting

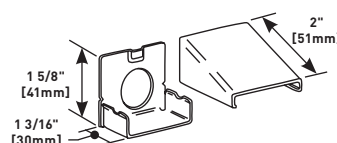

Connects 2400 Series Raceway with 1/2" trade size conduit or armored cable.

624BCK Replacement Blade Kit

Case hard steel replacement blades and die set for 624 Cutter.

2400D SERIES™ RACEWAY

2400D Series Raceway Wire Fill Capacities for Communications

	CABLE/ WIRE SIZE	O.D. (APPROX. DIA.)		1/3 COMP 40% FILL	2/3 COMP 40% FILL
		Inches	[mm]		
UNSHIELDED TWISTED PAIR	4-pair, 24 AWG, Cat 3	0.190	[4.8]	5	12
	4-pair, 24 AWG, Cat 5e	0.210	[5.3]	4	9
	4-pair, 24 AWG, Cat 6	0.250	[6.3]	3	7
	4-pair, 24 AWG, Cat 6a*	0.354	[9.0]	1	3
	25-pair, 24 AWG	0.410	[10.4]	1	2
COAXIAL	RG6/U	0.270	[6.9]	2	6
Fiber	ZipCord	0.118 x 0.236	[3 x 6]	5	12
	Round 4 Strand Fiber	0.187	[4.8]	5	12
	Round 6 Strand Fiber	0.256	[6.5]	2	6

2400D Series Raceway Wire Fill Capacities for Power

WIRE SIZE	O.D.		NUMBER OF CONDUCTORS (40%)	
	Inches	[mm]	1/3 COMP	2/3 COMP
THHN/THWN 14 AWG	0.111	[2.8]	11	26
12 AWG	0.130	[3.3]	9	19
10 AWG	0.164	[4.2]	6	11

NOTE: For additional information, refer to the Technical Section.

* Category 6 augmented (6a) cable for 10 gigabit ethernet – max allowed cable diameter per addenda No. 11 ANSI TIA/EIA 568-B.2.

2400D Series Raceway Ordering Information

V2400BD, 2400BD-FW Divided Raceway Base

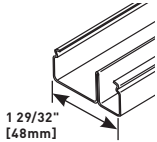

.040" [1.0mm] steel. Divided into two compartments (1/3 and 2/3 capacity). Packed ten 10' [3.0m] lengths per carton.

624BCK Replacement Blade Kit

Case hard steel replacement blades and die set for 624 Cutter.

V2400C, 2400C-FW Raceway Cover

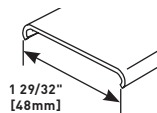

.040" [1.0mm] steel. Packed twenty 5' [1.5m] lengths per carton.

IWE-S, DVWE-S Spray Paint



Used for touching up large areas. Contains 12 oz. of paint. Available in ivory (IWE-S) and fog white (DVWE-S).

NOTE: Can only be shipped via ground transportation

624 2400 Series Raceway Base & Cover Cutter

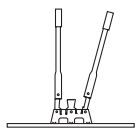

Portable cutter for 2400 & 2400D Series Raceway Base and Cover. Provides a clean and easy, square cut every time.

IWE-P, DVWE-P Touch-Up Paint Pen



Used for touching up small areas. Contains 0.3 oz. of paint. Available in ivory (IWE-P) and fog white (DVWE-P).

2400D Series Raceway Fittings Ordering Information

2400WC Wire Clip

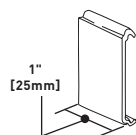

Additional support for conductors (nonmetallic).

2401D Divided Coupling

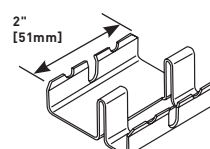

Joins lengths of 2400BD Divided Base.