

2000 SERIES® RACEWAY

2000 Series Raceway Wire Fill Capacities For Communications

	CABLE/WIRE SIZE	O.D. (APPROX. DIA.)		40% FILL
		Inches	[mm]	
UNSHIELDED TWISTED PAIR	4-pair, 24 AWG, Cat 3	0.190	[4.8]	11
	4-pair, 24 AWG, Cat 5e	0.210	[5.3]	9
	4-pair, 24 AWG, Cat 6	0.250	[6.3]	6
	4-pair, 24 AWG, Cat 6a*	0.354	[9.0]	3
	25-pair, 24 AWG	0.410	[10.4]	2
COAXIAL	RG6/U	0.270	[6.9]	5
FIBER	ZipCord	0.118 x 0.236	[3 x 6]	11
	Round 4 Strand Fiber	0.187	[4.8]	11
	Round 6 Strand Fiber	0.256	[6.5]	6

2000 Series Raceway Wire Fill Capacities For Power

WIRE SIZE	O.D.		NO. OF CONDUCTORS	
	Inches	[mm]	WITHOUT DEVICES	WITH PLUGMOLD RECEPTACLE
14 AWG	0.111	[2.8]	7	5
12 AWG	0.130	[3.3]	7	5

NOTE: For additional information, refer to the Technical Section.

* Category 6 augmented (6a) cable for 10 gigabit ethernet – max allowed cable diameter per addenda No. 11 ANSI TIA/EIA 568-B.2.

2000 Series Raceway Ordering Information

V2000BC, G2000BC Raceway Base & Cover

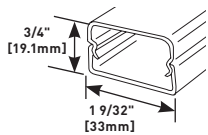

Packed ten (10) 5' [1.5m] lengths per carton.

V2000B-5, G2000B-5, V2000B-10, G2000B-10 Raceway Base

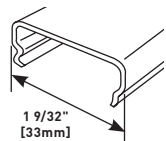

.040" [1.0mm] steel. Packed twenty (20) 5' [1.5m] lengths per carton. 10' [3m] lengths (V2000B-10, G2000B-10) are also available. Packed 100' [30.5m] per carton.

V2000BC, G2000BC Raceway Base & Cover

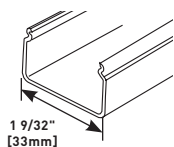

.025" [.8mm] steel. Packed twenty 5' [1.5m] lengths per carton. Shipped without receptacle hole cuts.

620 2000 Series Raceway Base & Cover Cutter

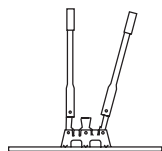

Portable cutter for both 2000 Series Raceway Base and Cover. Provides clean and easy square cuts every time.

620BCK Replacement Blade Kit

Case hard steel replacement blades and die set for 620 Cutter.

W30/W30G Pressure-Type Wire Connectors

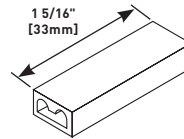

W30 – Common connection of two, three, or four No. 12 or No.14 solid copper conductors.

W30G – Connection of equipment grounding of 2, 3, or 4 solid conductors No. 14 or No. 12 AWG. 300V maximum; 20A 105° C maximum.

NOTE: Not for use with aluminum conductors.

2000WC Wire Clip (Galvanized)

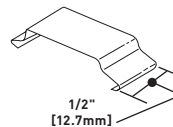

Additional support for conductors.

2001 Coupling (Galvanized)

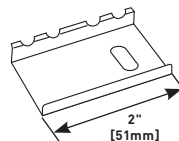

Connects lengths of 2000B Raceway Base.

V2003, 2003 Supporting Clip

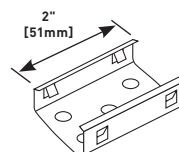

Supports lengths of 2000 Series Raceway at any point desired. Mounts to surface with No. 6 flathead screw. 2003 support clip has plated finish. V2003 has ivory finish.

PLUGMOLD® 2000 SERIES™



Two-piece, low profile multiple outlet raceway. Low profile requires minimal space.

CODE REFERENCE

cULus Listed Base & Blank Cover:
File E4376 Guide RJBT.

Multioutlet Assemblies:
File E15191 Guide PVGT.

Fittings:
File E41751 Guide RJPR.

Base & Blank Cover & Plugmold Series with Snapicoil Harness:
Meets Article 386 of NEC.
Meets Section 12-3032 of CEC.

Plugmold Wired Sections:
Meets Article 380 of NEC.
Meets Section 12-3032 of CEC.

Plugmold 2000 Series System Layout

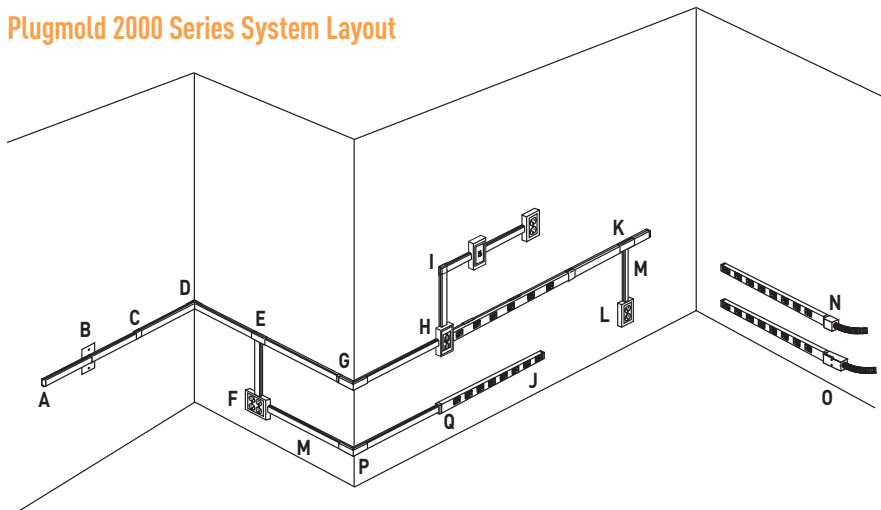

KEY

- A. V2010B Blank End Fitting
- B. V2051H Flush Plate Adapter
- C. V2006 Cover Clip
- D. 2017TC Internal Corner Coupling
- E. V2015 Tee Fitting
- F. V2048-2 Two-Gang Device Box
- G. V2018C Extern Elbow Cover
- H. V2048 Single-Gang Device Box
- I. V2011 90° Flat Elbow
- J. V20GB506 Plugmold Strip
- K. V2089 Side-Reducing Fitting
- L. V5748 Single-Gang Device Box
- M. V500 500 Series Raceway
- N. V2010A2 Entrance End Fitting
- O. V2010A3 Entrance End Fitting
- P. V518 External Elbow
- Q. V2089E End-Reducing Connector

NOTE: Illustration is for showing product applications only.

COLOR OPTIONS



Plugmold® 2000 Series™ Part Numbers with a "V" prefix have an ivory finish. Part Numbers with a "G" prefix have a gray finish. Part Numbers with a "S" prefix have a stainless finish. Part Numbers with a "WH" prefix have a white finish. Part Numbers with a "BK" prefix have a black finish. Part Numbers without a prefix have a galvanized steel finish unless otherwise specified.

Custom color options are also available. Consult the factory for more information.

PLUGMOLD® 2000 SERIES™

Plugmold 2000 Series Ordering Information

2000BC Base and Cover

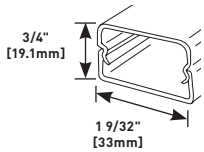

2000B Base: .040" [1.0mm] steel; 2000C Cover: .025" [.6mm] steel. Packed ten 5' [1.5m] lengths of each per carton. Available in ivory (V2000BC), gray (G2000BC), black (BK2000BC), white (WH2000BC) and stainless steel (S2000BC).

2000B-5 Raceway Base

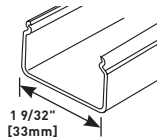

.040" [1.0mm] steel. Packed twenty 5' [1.5m] lengths per carton. Available in ivory (V2000B-5), gray (G2000B-5), black (BK2000B-5), white (WH2000B-5) and stainless steel (S2000B-5).

2000B-10 Raceway Base

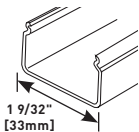

.040" [1.0mm] steel. Packed ten 10' [3.05m] lengths per carton. Available in ivory (V2000B-10), gray (G2000B-10), black (BK2000B-10), white (WH2000B-10) and stainless steel (S2000B-10).

2000C Raceway Base

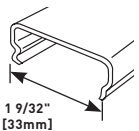

.025" [.6mm] steel. Packed twenty 5' [1.5m] lengths per carton. Has no receptacle hole cuts. Available in ivory (V2000C), gray (G2000C), black (BK2000C), white (WH2000C) and stainless steel (S2000C).

620 Raceway Base and Cover Cutter

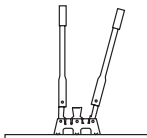

Portable cutter for both 2000 Base and Cover.

620BCK Replacement Blade Kit

Replacement blades and die set for 620 Cutter.

W30/W30G Pressure-Type Wire Connectors

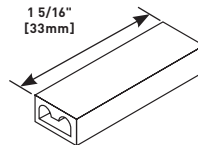

NOTE: Not for use with aluminum conductors.

W30 – For common connection of two, three, or four No. 12 or No.14 solid copper conductors.

W30G – For connection of equipment grounding of 2, 3, or 4 solid conductors No. 14 or No. 12 AWG. 300V maximum; 20A 105° C maximum.

2000WC Wire Clip (Plated)

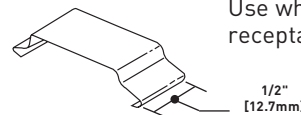

Use when conductors bypass receptacles. Not UL Listed.

2001 Coupling (Galvanized Steel)

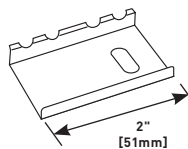

Joins lengths of 2000 Series Raceway Base.

2003 Supporting Clip

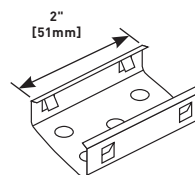

Temporary support, while positioning lengths of raceway base. Use with 2000 Series Raceway. V2003 has ivory finish; 2003 has plated finish.

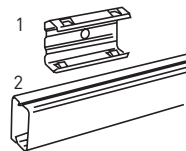

- 2003 mounted on surface with No. 6 flathead screw.
- Plugmold 2000 or 2100 snaps into 2003 Supporting Clip.

2006 Cover Clip

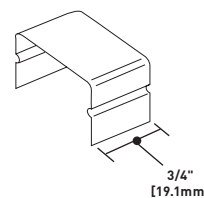

Covers seam where lengths of cover or base meet. Available in ivory (V2006), gray (G2006), black (BK2006), white (WH2006) and stainless steel (S2006).