

# EVOLUTION™ SERIES FLOOR BOXES



Wiremold® Evolution™ Series Floor Boxes are the latest advancement in the most complete and innovative line of floor solutions in the industry.



## CODE REFERENCE

cULus Listed  
**Metallic Outlet Boxes:**  
 File E2961 Guide QCIT.  
 Meets Article 314.27(C) of NEC.

## Evolution™ Series Floor Box Components

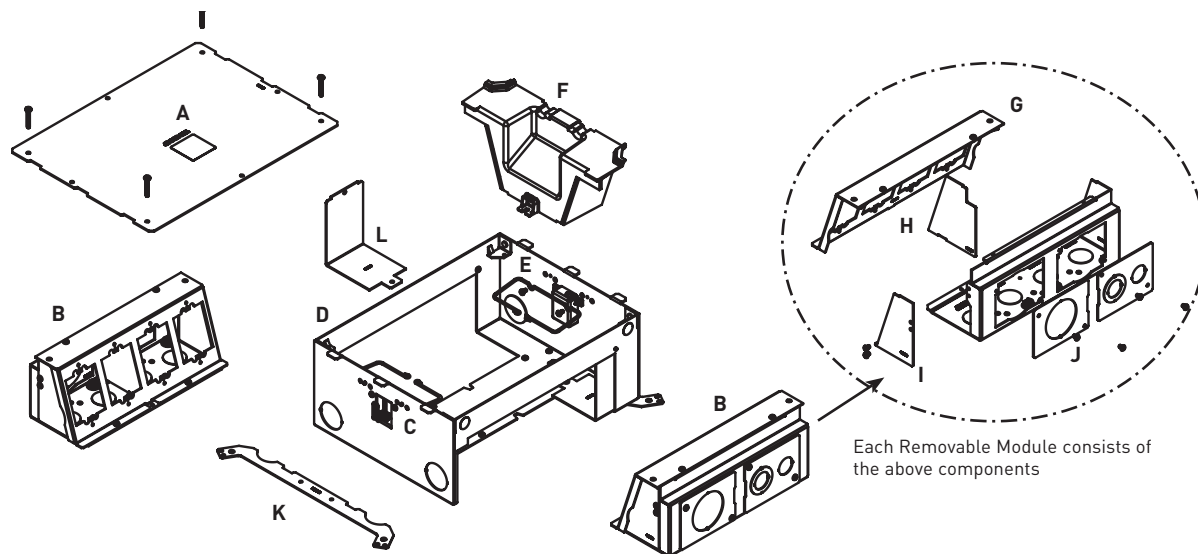

### KEY

- |   |                                       |
|---|---------------------------------------|
| A. Mud Cap (temporary construction cover) | G. Mounting Bracket                   |
| B. Removable Module                       | H. Divider (removable repositionable) |
| C. Toggle Clamp                           | I. End Cap                            |
| D. Box                                    | J. Back Knockout Plate                |
| E. Cable Guide                            | K. Concrete Level Leg                 |
| F. Tunnel                                 | L. "L" Bracket                        |

All items shown above are included with Evolution Series floor boxes.

### COLOR OPTIONS



Evolution Series Floor Box Covers are available in the following powder coated finishes: "BK" black, "GY" gray, "NK" nickel, "BS" brass, and "BZ" bronze.

**Custom color options are also available. Consult the factory for more information.**

# EVOLUTION™ SERIES FLOOR BOXES

## Evolution™ Series 10-Gang Floor Box Accessories Ordering Information (continued)

### EFB10-B Device Plate



Blank device plate. Device plate dimensions: 2.3" x 4.652" [58mm x 118mm].

### EFB10-6AB Device Plate

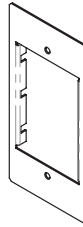

Accepts up to three (3) dual Wiremold Open System communication adapters. Adapters sold separately. Device plate dimensions: 2.3" x 4.652" [58mm x 118mm].

### EFB10-DP Device Plate

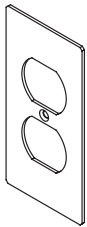

Duplex device plate. Device plate dimensions: 2.3" x 4.652" [58mm x 118mm]. Includes receptacle spacers.

### EFB10-3S2 Device Plate

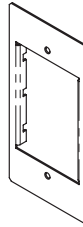

Accepts up to three (3) Ortronics® Series II devices. Ortronics® devices sold separately. Device plate dimensions: 2.3" x 4.652" [58mm x 118mm].

### EFB10 -DEC Decorator Style Device Plate

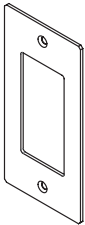

For use with decorator style receptacles, GFCI receptacle, and decorator style audio/ video devices. Device plate dimensions: 2.3" x 4.652" [58mm x 118mm]. Includes receptacle spacers.

### EFB10-2C Device Plate

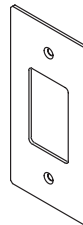

Accepts one dual Wiremold Open System adapter, or one Ortronics® Series II adapter, or one Ortronics® TracJack adapter. Adapters sold separately. Device plate dimensions: 2.3" x 4.652" [58mm x 118mm].

### EFB10-S1 Knockout Plate



Single receptacle 1.39" [35mm]. diameter. Device plate dimensions: 2.3" x 4.652" [58mm x 118mm]. Includes receptacle spacers.

### EFB10-AAP Device Plate

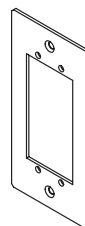

Holds two (2) Extron® Electronics AAP devices. Device plate dimensions: 2.3" x 4.652" [58mm x 118mm].

### EFB10-S2 Knockout Plate

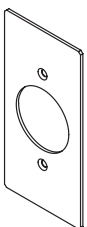

Single receptacle 1.59" [40mm] diameter. Device plate dimensions: 2.3" x 4.652" [58mm x 118mm]. Includes receptacle spacers.

### EFB10-MAAP Device Plate

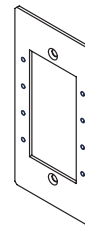

Holds four (4) Extron® Electronics MAAP devices. Device plate dimensions: 2.3" x 4.652" [58mm x 118mm].