

# FLOOR BOX SYSTEMS

## Quick Selection Guide

Wiremold® Floor Boxes are TopGuard protected to meet and exceed the UL scrub water exclusion requirement.



### Above-Grade Floor Boxes for Concrete Floors (continued)

STEEL BOXES (continued)										
Box Model	Box Type	Service Capability	Box Capacity	Box Construction	Depth Behind Device Plates	KO Sizes	Cover Model	Cover Construction	Cover & Flange Part Nos.	Notes
<b>Evolution Series EFB6S</b>	Rectangular	Triple	6 Gangs	Steel	3 7/8" [98mm]	3/4" - 2" Trade Size	Die-Cast Aluminum	Tile, Carpet, Wood, Terrazzo, Polished Concrete	EFB610CTC, EFB610BTC, EFB610BT, EFB610CT	Removable Modules, Standard size Device Plates
<b>Evolution Series EFB8S</b>	Rectangular	Triple	8 Gangs	Steel	3 1/2" [89mm]	3/4" - 2" Trade Size	Die-Cast Aluminum	Tile, Carpet, Wood, Terrazzo, Polished Concrete	EFB610CTC, EFB610BTC, EFB610BT, EFB610CT	Removable Modules, Standard size Device Plates
<b>Evolution Series EFB10S</b>	Rectangular	Triple	10 Gangs	Steel	3 1/4" [83mm]	3/4" - 2" Trade Size	Die-Cast Aluminum	Tile, Carpet, Wood, Terrazzo, Polished Concrete	EFB610CTC, EFB610BTC, EFB610BT, EFB610CT	Removable Modules, Finished Interior
<b>CCBB Series CCBS, CCBS, CCBS</b>	Rectangular	Triple	12 Gangs	Steel	<b>CCBS:</b> 3 3/4" [95mm] <b>CCBSL:</b> Custom	<b>CCBS:</b> 3/4" - 2" Trade Size <b>CCBSL:</b> Field Punched	Cast Aluminum	Carpet	CCBSCTCAL, CCBSLCTCAL	Recessed Devices, Adjustable Pre-pour
<b>CCFB Series</b>	Rectangular	Multi	Custom	Steel	Custom	Field Punched	Cast Aluminum	Tile, Carpet, Bare Concrete	CCFBCTC	Power, A/V, Comm., Water, Air

### Floor Boxes for Wood Floor

COMMERCIAL BOXES										
Box Model	Box Type	Service Capability	Box Capacity	Box Construction	Depth Behind Device Plates	KO Sizes	Cover Construction	Cover Type	Cover & Flange Part Nos.	
<b>861 Series</b>	Round	Single	1 Gang	Die-Cast Aluminum	N/A	1/2" Trade Size	Brass, Brushed Aluminum	Tile, Carpet	895 Series & Poke-Thru Covers	
<b>863 Series</b>	Round	Dual	2 Gangs	PVC	N/A	1/2" Trade Size Romex strain relief pass-through opening for communications.	Brass, Brushed Aluminum	Carpet	Included with Kits	
<b>880W Series, 880W1</b>	Rectangular	Single	1 Gang	Steel	2 3/4" [70mm]	1/2" & 3/4" Trade Size	Brass, Brushed Aluminum, Nonmetallic	Tile, Carpet	817, 818, 828, 829, 830 Series	
<b>880W Series, 880W2</b>	Rectangular	Dual	2 Gangs	Steel	2 3/4" [70mm]	1/2" & 3/4" Trade Size	Brass, Brushed Aluminum, Nonmetallic	Tile, Carpet	827, 828, 829, 830 Series	
<b>880W Series, 880W3</b>	Rectangular	Triple	3 Gangs	Steel	2 1/4" [57mm]	1/2" & 3/4" Trade Size	Brass, Brushed Aluminum, Nonmetallic	Tile, Carpet	828, 829, 830, 837, 838 Series	
<b>CRFB Series</b>	Round	Triple	4 Gangs	Die-Cast Aluminum	2 1/4" [57mm]	1/2, 3/4", 1", 1 1/4" & 2" Trade Size	CRFB & Evolution Die-Cast Aluminum	Tile, Carpet	CRFBCTC, CRFBBTC, 8AT Series	

**NOTE:** Most Wiremold floor boxes and accessories are listed by Underwriters Laboratories Inc., and comply with Federal Specifications W-C-583b in one of the following types and classes: Type I-Fully adjustable, Type II-Semi-adjustable, Type III-Non-adjustable, Class 1-Watertight, Class 2-Concrete-tight.

# EVOLUTION™ SERIES FLOOR BOXES

## Evolution™ Series Floor Box Model Selection Guide

EVOLUTION FLOOR BOX MODEL	EFB6S	EFB6S-OG	EFB6S-FC	EFB8S	EFB8S-OG	EFB8S-FC	EFB10S	EFB10S-OG	EFB10S-FC	EFBFF	EFBFF-OG
INSTALL FLOOR TYPE: Concrete Floor Raised Floor Wood Floor	YES YES YES	YES	YES	YES YES YES	YES	YES	YES YES YES	YES	YES	YES YES YES	YES
BOX TYPE:	Standard	On-Grade	Fire Classified	Standard	On-Grade	Fire Classified	Standard	On-Grade	Fire Classified	Furniture Feed	Furniture Feed
BOX CAPACITY:	6-Gangs	6-Gangs	6-Gangs	8-Gangs	8-Gangs	8-Gangs	10-Gangs	10-Gangs	10-Gangs	2-Gangs	2-Gangs
DEPTH BEHIND PLATES:	3 7/8" [98mm]	3 7/8" [98mm]	3 7/8" [98mm]	3 1/2" [89mm]	3 1/2" [89mm]	3 1/2" [89mm]	3 1/2" [89mm]	3 1/2" [89mm]	3 1/2" [89mm]	N/A	N/A
REMOVABLE MODULES:	YES	YES	YES	YES	YES	YES	YES	YES	YES		
DEVICE PLATE SIZE:	Uses Standard Size Device Plates: Single-Gang [2 3/4" x 4 1/2"] [70mm x 114mm]			Uses Standard Size Device Plates: Single-Gang [2 3/4" x 4 1/2"] Double-Gang [4 9/16" x 4 1/2"] Triple-Gang [6 3/8" x 4 1/2"]			Uses Non-Standard Size Device Plates [4.652" x 2.302"] [117mm x 58mm]				
COVERS: COLORS:	EFB610CTC Series, EFB610BTC Series, EFB610CT Series, EFB610BT Series Black, Gray, Brass, Nickel, Bronze									FPFFTC Series Black, Gray, Brass, Nickel, Bronze, Brushed Aluminum	
FLOOR SURFACE:	Carpet, Tile, Wood, Bare (Polished) Concrete & Terrazzo									Carpet, Tile & Wood	
KO SIZE RANGE: (TRADE SIZE)	3/4" to 2"	3/4" to 2"	1 1/4"	3/4" to 2"	3/4" to 2"	1 1/4"	3/4" to 2"	3/4" to 2"	1 1/4"	1/2" to 2"	1/2" to 2"
FIRE RATING: (HOURS)			Up to 2 Hours			Up to 2 Hours			Up to 2 Hours		

**NOTE:** Covers open full 180°, slide cable egress doors, painted interior.

## Evolution Series Floor Box Compartment Volumes

MODEL	OUTER COMPARTMENTS (EACH)		CENTER COMPARTMENTS (EACH)	
EFB6 SERIES	32 in. <sup>3</sup>	[524ml]	38.5 in. <sup>3</sup>	[630ml]
EFB8 SERIES	27.5 in. <sup>3</sup>	[450ml]	34 in. <sup>3</sup>	[557ml]
EFB10 SERIES	23.5 in. <sup>3</sup>	[385ml]	27.5 in. <sup>3</sup>	[450ml]
EFBFF SERIES	64.5 in. <sup>3</sup>	[1056ml]	64.5 in. <sup>3</sup>	[1056ml]



### Finished Interior

Fully finished interior removes the unfinished industrial look while increasing visibility, making it easier to see where to plug in devices.



### Configurable with Removable Modules

In addition to having removable dividers and a tunnel feature that allows all compartments to be connected, the modules are removable through the top or back of the floor box. This allows for easier installations and facilitates moves, adds and changes without having to disconnect services, saving time and money.

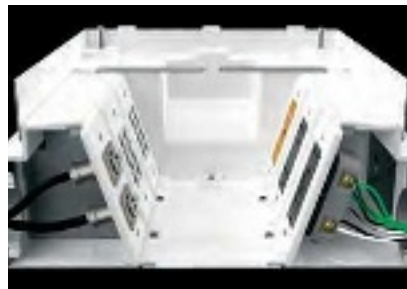

### Audio/Video Design

Evolution Series Floor Boxes have been developed specifically with the A/V industry in mind. With 3 1/2" – 3 7/8" [89mm x 98mm] of wiring capacity behind each device plate, these boxes will accept devices from leading A/V manufacturers including Extron® Electronics and Crestron®.



### Durable 180° Articulating Hinge

Hinge design enables covers to open a full 180° and lie flat on the floor surface with the durability to support a large cover. Provides easy access to all interior modules and activations while reducing tripping hazards.

# EVOLUTION™ SERIES FLOOR BOXES

## Evolution™ Series 6-Gang Floor Boxes Ordering Information

### EFB6S 6-Gang Floor Box

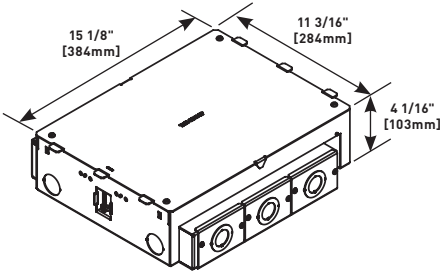

Designed to be installed in concrete floors, raised floors, and wood floor applications. Box has a fully finished interior to assist plugging and unplugging of devices. Designed to work with standard size wall plates. **Box comes complete with all components needed for initial installation. Included components are:** Protective/ Disposable cover, tunnel system for connecting the two modules of compartments, two (2) removable modules, two (2) toggle clamps to secure box to raised and wood floors, two (2) cable management guides, two (2) leveling support legs for concrete applications and trade size knockouts ranging in size from 3/4" to 2" trade size. **Items not included with the box and sold separately are:** receptacles, communication jacks, and A/V devices and device plates. Box is compatible with Wiremold® Walkerflex Modular Wiring System. Custom options are available upon request.

**NOTE:** For use on bare (polished) concrete or terrazzo floors EFB610-CTR must be used (sold separately).

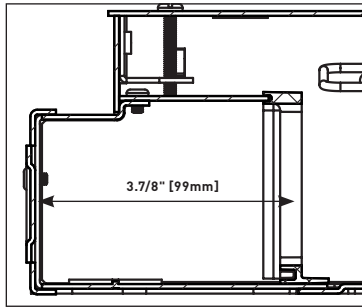

EFB6 Depth Behind Plates

Three (3) KOs:  
Outer: 1 1/4" Trade Size KO  
Inner: 3/4" Trade Size KO

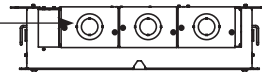

Two (2) KOs:  
1" Trade Size KO

Four (4) 1" Trade Size KOs

Two (2) KOs:  
1" Trade Size KO

Three (3) KOs:  
Outer: 1 1/4" Trade Size KO  
Inner: 3/4" Trade Size KO

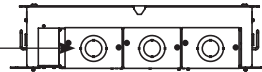

Two (2) KOs:  
Outer: 2" Trade Size KO  
Inner: 1" Trade Size KO

### EFB6S-OG Six-Gang Floor Box

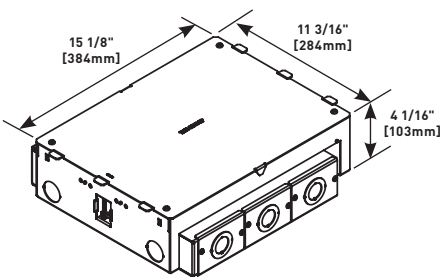

Designed to be installed in both on-grade and above grade concrete floor applications. Box has an epoxy coating that allows the box to be placed in on-grade applications without the need for additional vapor barriers. Designed to work with standard size wall plates. **Box comes complete with all components needed for initial installation. Included components are:** protective/disposable cover, tunnel system for connecting the two modules of compartments, two (2) removable modules, two (2) cable management guides, two (2) leveling support legs for concrete applications and trade size knockouts ranging in size from 3/4" to 1 1/4". **Items not included with the box and sold separately are:** receptacles, communication jacks, and A/V devices and device plates. Custom options are available upon request.

**Note:** For use on bare (polished) concrete or terrazzo floors EFB610-CTR must be used (sold separately).

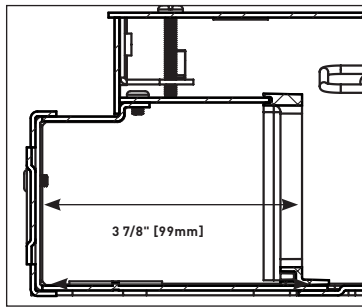

EFB6-OG Depth Behind Plates

Three (3) KOs:  
Outer: 1 1/4" Trade Size KO  
Inner: 3/4" Trade Size KO

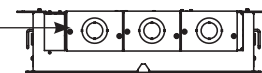

Two (2) KOs:  
1" Trade Size KO

Four (4) 1" Trade Size KOs

Two (2) KOs:  
1" Trade Size KO

Three (3) KOs:  
Outer: 1 1/4" Trade Size KO  
Inner: 3/4" Trade Size KO

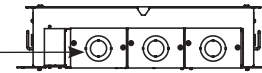

Two (2) KOs:  
Outer: 2" Trade Size KO  
Inner: 1" Trade Size KO