

# ECLIPSE™ SERIES RACEWAYS

## Single Channel



One-piece, latching, single-channel raceway available in three profiles. Easy-to-install and ideal for demanding communication designs. Accommodates communication or power wiring.

### CODE REFERENCE

**cULus Listed Raceway:**  
File E90378 Guide RJTX.  
Complies with flammability requirements of UL-5A.

**Fittings:**  
File E90377 Guide RJYT.  
Meets Article 388 of NEC.  
UL Listed for up to 600V.  
Meets Section 12-1600 of CEC.

### Eclipse Series PN03, PN05, PN10 Raceways System Layout

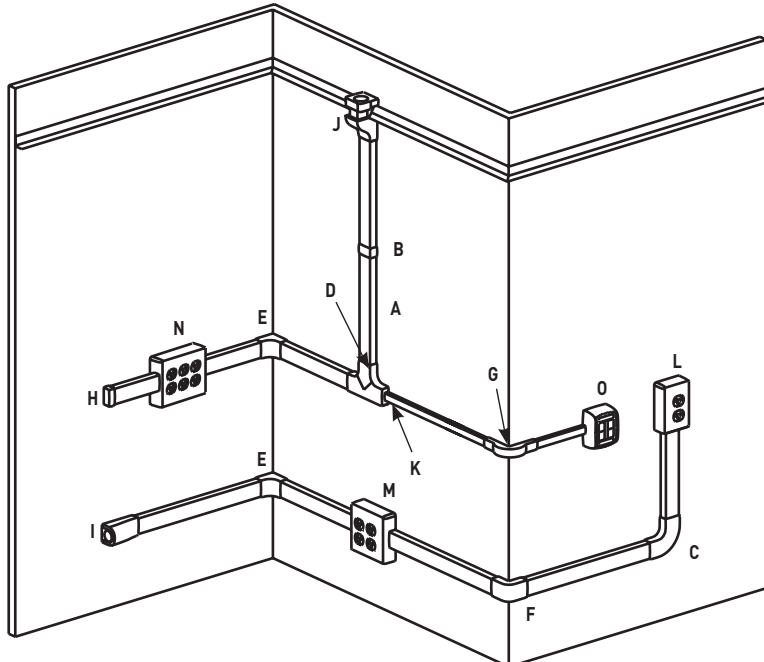

**NOTE:** Illustration is for showing product applications only.

### KEY

- A. PN03L08, PN03L10, PN05L08, PN05L10, PN10L08, PN10L10 Latching Raceway
- B. PN03F06, PN05F06, PN10F06 Cover Clip
- C. PN03F11, PN05F11, PN10F11 90° Flat Elbow Fitting
- D. PN03F15, PN05F15, PN10F15 Tee Fitting
- E. PN03F17, PN05F17, PN10F17 Internal Elbow Fitting
- F. PN03F18, PN05F18, PN10F18 External Elbow Fitting
- G. PN03F19, PN05F19, PN10F19 Bend Radius External Elbow Fitting
- H. PN03F20, PN05F20, PN10F20 Blank End Fitting
- I. PN10F21 Entrance End Fitting
- J. PN05F86, PN10F86 Drop Ceiling Connector
- K. PN153R Reducer Adapter
- L. PSB1 One-Gang Device Box
- M. PSB2 Two-Gang Device Box
- N. PSB3 Three-Gang Device Box
- O. PBB2S2, PBB4TJ, PDB1CM, PDB1S2, PDB2CM, PDB2S2, PDB4TJ Communication Box

### COLOR OPTIONS



Eclipse™ Series Raceway Part Numbers with a "-WH" suffix have a white finish. Part Numbers with a "-FW" suffix have a fog white finish. Part Numbers with a "-V" suffix have an ivory finish. Eclipse Series Raceways are paintable using latex paint.

# ECLIPSE™ SERIES RACEWAYS

## Ordering Information

### PN03F15, PN05F15, PN10F15 Tee

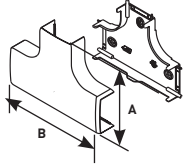

For branches of raceway running at right angles. 1" [25mm] bend radius.

CAT. NO.	A	B
PN03F15-FW, -WH, -V	2 11/16" [68mm]	4 5/16" [110mm]
PN05F15-FW, -WH, -V	2 15/16" [75mm]	4 3/4" [121mm]
PN10F15-FW, -WH, -V	3 11/16" [94mm]	5 5/16" [135mm]

### PN03F17, PN05F17, PN10F17 Internal Elbow

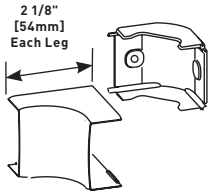

For right angle turns around internal corners. 1" [25mm] bend radius. Available in fog white (PN03F17-FW, PN05F17-FW, PN10F17-FW), white (PN03F17-WH, PN05F17-WH, PN10F17-WH), and ivory (PN03F17-V, PN05F17-V, PN10F17-V).

### PN03F18, PN05F18, PN10F18 External Elbow

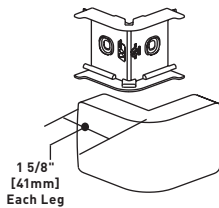

For right angle turns around external corners. Available in fog white (PN03F18-FW, PN05F18-FW, PN10F18-FW), white (PN03F18-WH, PN05F18-WH, PN10F18-WH), and ivory (PN03F18-V, PN05F18-V, PN10F18-V).

### PN03F19, PN05F19, PN10F19 Radiused Extruded Elbow

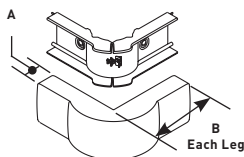

For right angle turns around external corners. 1" [25mm] bend radius.

CAT. NO.	A	B
PN03F19-FW, -WH, -V	15/16" [23.8mm]	3 1/8" [79mm]
PN05F19-FW, -WH, -V	1 3/16" [30mm]	3 1/8" [79mm]
PN10F19-FW, -WH, -V	1 3/16" [30mm]	3 3/8" [116mm]

### PN03F20, PN05F20, PN10F20 Blank End Fitting

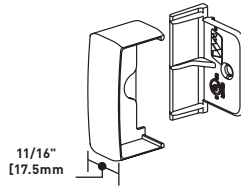

For closing open end of Eclipse PN03, PN05, or PN10 Series Raceway. Available in fog white (PN03F20-FW, PN05F20-FW, PN10F20-FW), white (PN03F20-WH, PN05F20-WH, PN10F20-WH), and ivory (PN03F20-V, PN05F20-V, PN10F20-V).

### PN153R Reducer Adapter Fitting

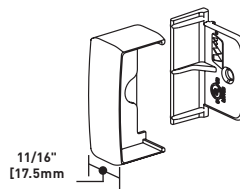

For adapting PN03 or PN05 Series Raceway to a PN10 Series Raceway trunking through the PN10F15 Tee Fitting. Available in fog white (PN153R-FW), white (PN153R-WH), and ivory (PN153R-V).

### PN05F86, PN10F86 Drop Ceiling Connector

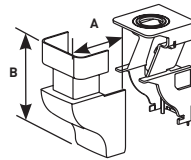

For dropping cables from ceiling into the raceway. Has 1/2" and 3/4" concentric trade size KO's. Includes PN153R Reducer Adapter for use with PN03 Series Raceway.

CAT. NO.	A	B
PN05F86-FW, -WH, -V	1 5/16" [33mm]	4 3/8" [111mm]
PN10F86-FW, -WH, -V	2 1/2" [64mm]	4 3/8" [111mm]

### PN10F21 Entrance End Fitting

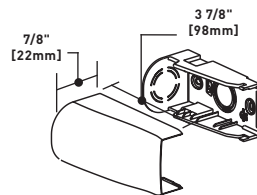

For feeding raceway with 1/2" and 3/4" trade size conduit or armored cable. Has 1/2 and 3/4" concentric trade size KO's. Includes PN153R Reducer Adapter for use with PN03 and PN05 Series Raceway. Available in fog white (PN10F21-FW), white (PN10F21-WH), and ivory (PN10F21-V).