





Device Boxes

Stainless Steel Wall Plates



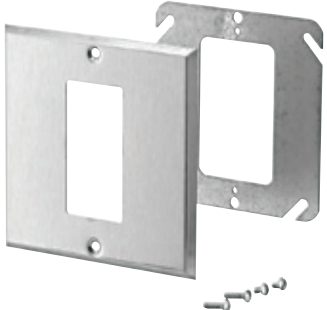

Specialty Usage

Telephone		Emergency	Single Receptacle	GFCI Conversion Kit
				
* CI97181 3/8 in. opening.	* CI97191 5/8 in. opening.	CI6851-RF ON / OFF	CI97091 1-13/32 in. diameter.	BC97002 For 4 in. square boxes.

347 V Toggle Specialty Usage

For 1204 Series			For MBD / MBS Series
			
CI6851-HV	CI6854-HV 1 gang to 4 gangs	CI6851-HV	CI97074-HVR 1 gang to 4 gangs

347 V Blank

For 1204 Series		For MBD/MBS Series	
			
CI97151-HV	CI97154-HV 1 gang, 2 gangs and 4 gangs	CI97151-HV	CI97154-HVR 1 gang, 2 gangs and 4 gangs

Device Boxes

Stainless Steel Wall Plates

Dimensions

Standard all Plate

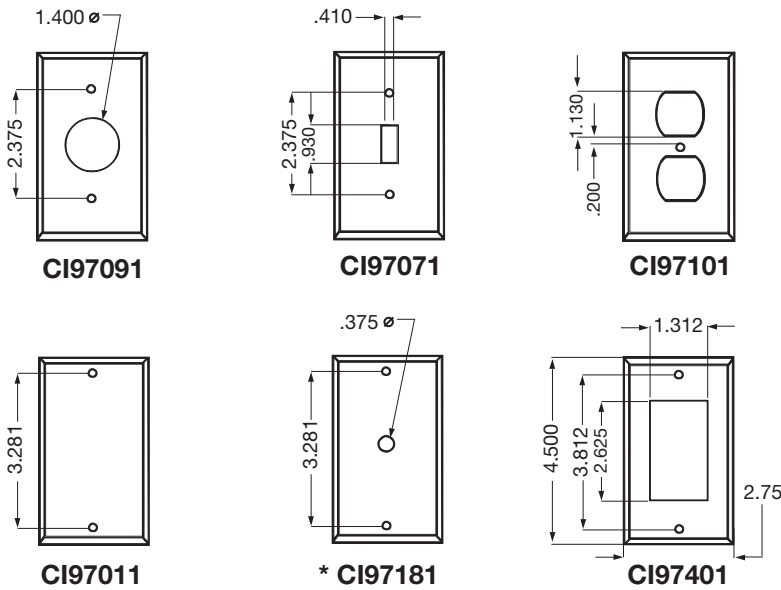

Mounting Hole Spacings

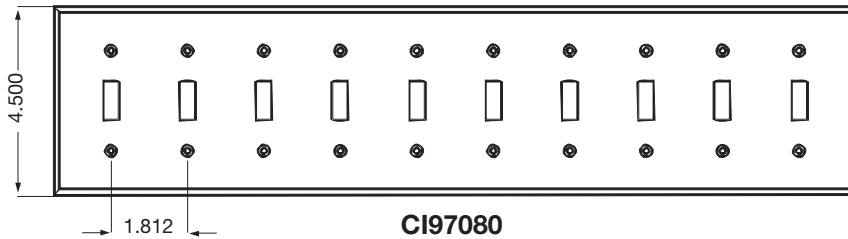
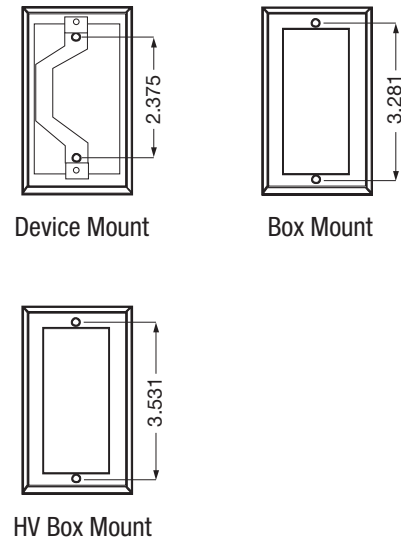

347 V Wall Plate

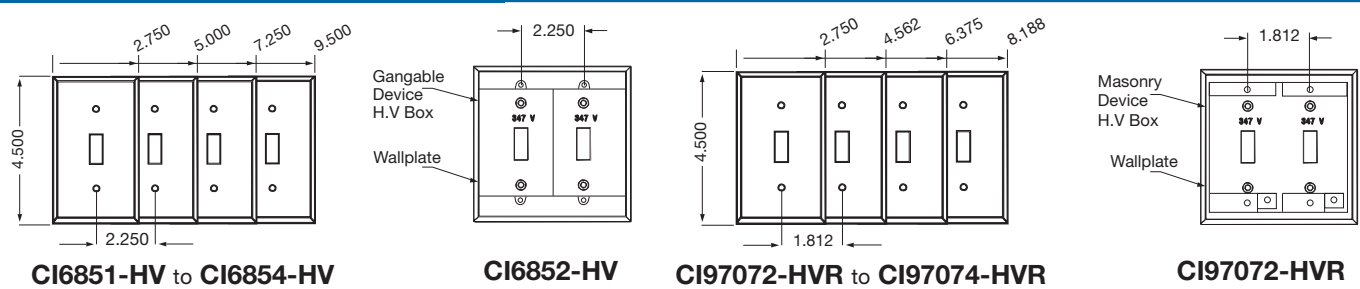

Dimensions are in inches.

Device Boxes

Stainless Steel Wall Plates

Selection Guide

DESCRIPTION	1 GANG	2 GANGS	3 GANGS	4 GANGS	5 GANGS	6 GANGS	7 GANGS	8 GANGS	9 GANGS	10 GANGS
Toggle Switch	CI97071	CI97072	CI97073	CI97074	CI97075	CI97076		CI97078	CI97079	CI97080
Duplex Receptacle	CI97101	CI97102								
Blank Boxes										
Mounting 3.281 in.	CI97011	CI97012	CI97013	CI97014						
Blank Device										
Mounting 2.375 in.	CI97121	CI97122	CI97123	CI97124						
GFCI / Decora	CI97401	CI97402	CI97403	CI97404	CI97405	CI97406				
GFCI Conversion Kit		BC97002								
Combination										
Switch / Receptacle		CI97532			CI97563	CI97573				
15 A Receptacle	CI97091									
Telephone 3/8 in. Opening	* CI97181									
Telephone 5/8 in. Opening	* CI97191									
Emergency On / Off	CI6851-RF									
347 V Toggle										
for 1204 Series	CI6851-HV	CI6852-HV	CI6853-HV	CI6854-HV						
347 V Blank										
for 1204 Series	CI97151-HV	CI97152-HV		CI97154-HV						
347 V Toggle	USE									
for MBD and MBS Series	CI6851-HV	CI97072-HVR	CI97073-HVR	CI97074-HVR						
347 V Blank	USE									
for MBD and MBS Series	CI97151-HV	CI97152-HVR		CI97154-HVR						

 * Not applicable.

Technical Specifications

Type 430 Stainless Steel

- 16% chrome
- Corrosion resistant
- Recommended for industrial, commercial and institutional applications
- Supplied with nickel plated brass screws
- 1 to 3 gangs — Vertically Brushed
- 4 gangs and up — Horizontally Brushed