

Surface Raceway and Lighting Systems

Fixture Fittings

Pre-Galvanized Steel Closure Strip

AB844PGC
AB844PGCWH White Epoxy Powder Coated

Plastic Closure Strip

AB844PC Color : Gold
AB844PCGY Color : Grey

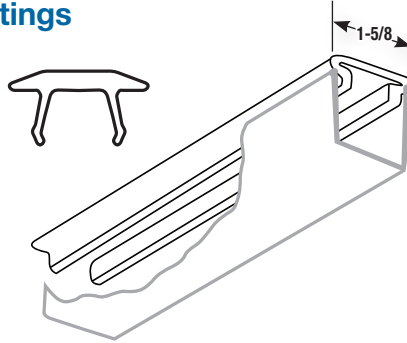

- When used as a raceway, channel is normally installed with the slot up. After wiring has been completed the closure strip is installed.
- For all channels.
- Standard length: 10 ft.



Stainless Steel Closure Strip

AB844SS6CS

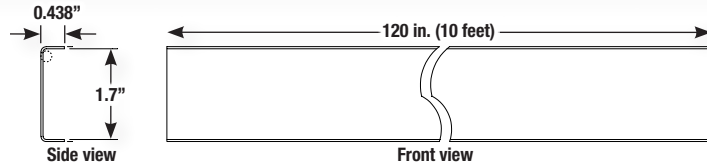

Note:
Strapping not included.

AB803 Cast Conduit Connector

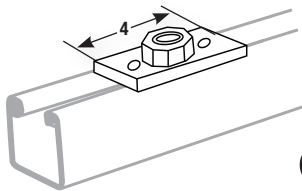

To connect 1/2 in. or 3/4 in. conduit to raceway channel. Furnished complete with stud nuts and hex nuts. Part has removable bushing to increase size from 1/2 in. to 3/4 in.

Wt./C 60 lb.

AB815 Swing Connector

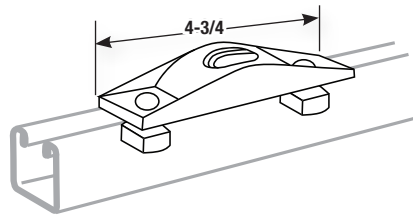

Nuts and bolts to clamp to channel is included. For 1/2 in. or 3/4 in. conduit.

Wt./C 95 lb.

AB885 15° Swivel

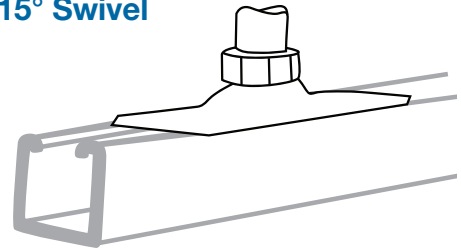

Nuts and bolts to clamp to channel included. For 1/2 in. or 3/4 in. conduit.

Wt./C 25 lb.

AB867 Spacer

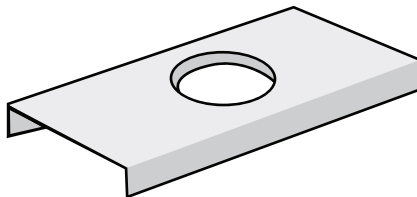

For use with AB866 wiring stud nuts.

Wt./C 24 lb.

AB866 Wiring Stud Nut

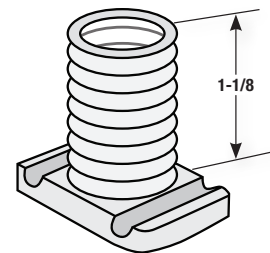

1/2 in. Pipe thread
Wt./C 21 lb.

811 Stud Nut

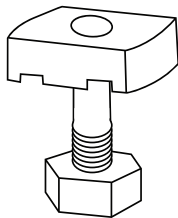

Cat. No.	For Channel	Wt./C lb.
811-1STR	1/4 x 1	8
811-2STR	1/4 x 1-1/4	9

812 Stud Nut

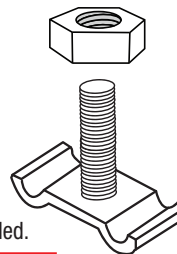

For attaching fixture to slot down channel or to slot up knockouts. Specify length. Hex nut included.

Cat. No.	For Channel	Wt./C lb.
812-1EG	1/4 x 1	6

AB868 Fiber Retainer for Cables Until Closure Strip is Installed

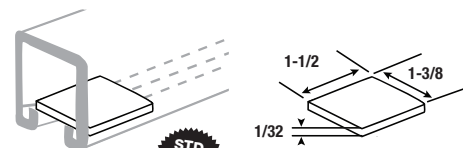

Wt./C 3 lb.

