

Features, Brackets, Clamps, Knockouts

Technical Specifications

IBERVILLE® steel boxes and covers are manufactured from hot dipped galvanized steel sheet. Hot dipped galvanizing is one of the most effective methods of protecting bare steel from corrosion. This zinc coating is uniformly distributed both inside and outside the box, and not only protects the surface of the steel but also sacrifices itself through galvanic action to prevent corrosion at edges, holes (plain or tapped) and possible scratches. The use of hot dipped galvanized steel sheet ensures full zinc protection for all **IBERVILLE®** steel boxes and covers.

Ears



IBERVILLE® steel boxes incorporate numerous features which result in boxes rugged enough to stand up against the severest abuse.

- Pre-set positioning tabs for perfectly aligned installation
- Formed stabilizing embosses, which prevent rocking and will not flatten under the impact of a hammer
- The Wedgelock system, which locks sides even tighter together when installed
- Diamond shaped pryouts, for easy removal
- Loomex cable clamps, with supporting legs that maintain elevation for easier cable entry
- Combination "slot / Robertson head" screws, which allow the use of more than one type of screwdriver
- Large pan head ground screws above two wire retainers
- Various types of brackets for different applications

Rework Mounting Systems*

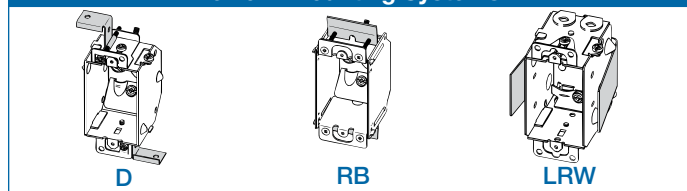

* C.E.C. 2012 Rule 12-3010 (2)
Where ganged sectional boxes are used, they shall be secured to metal supports or to wooden boards at least 19 mm thick that are rigidly secured to the structural units.

Knockouts / Pryouts

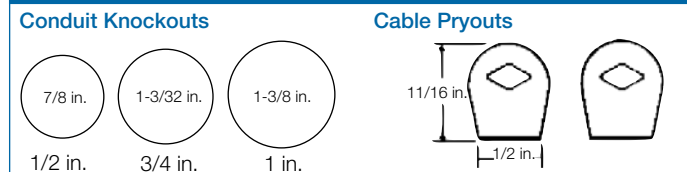

Clamps



Device Boxes

Clamp for nonmetallic sheathed cable "Loomex".



Octagonal Boxes

Clamp for nonmetallic sheathed cable "Loomex".

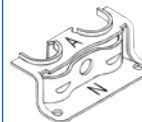

Clamp for armored cable "BX" & nonmetallic sheathed cable "Loomex".

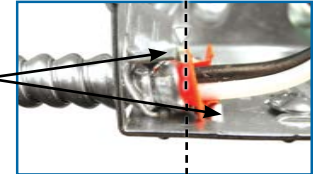

Our "LA" cable clamp: This clamp has been designed so that the anti-short bushing and the armour butt-up against a retaining wall built into the clamp.

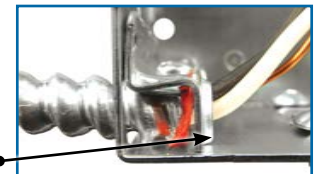

Our dual usage boxes feature retaining flanges built into the bottom of the spacer, that in unison with the cable clamp, hold the anti-short bushing in place and prevent the armour from penetrating into the box.

Brackets

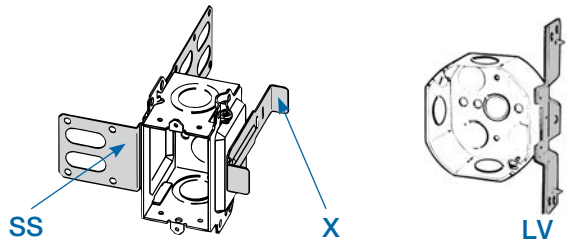
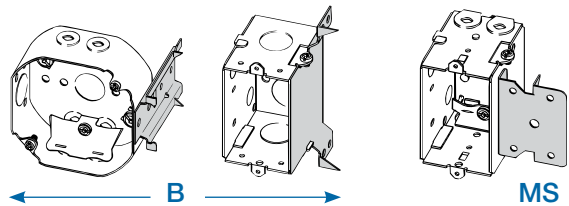

4 in. Square Boxes

Covers

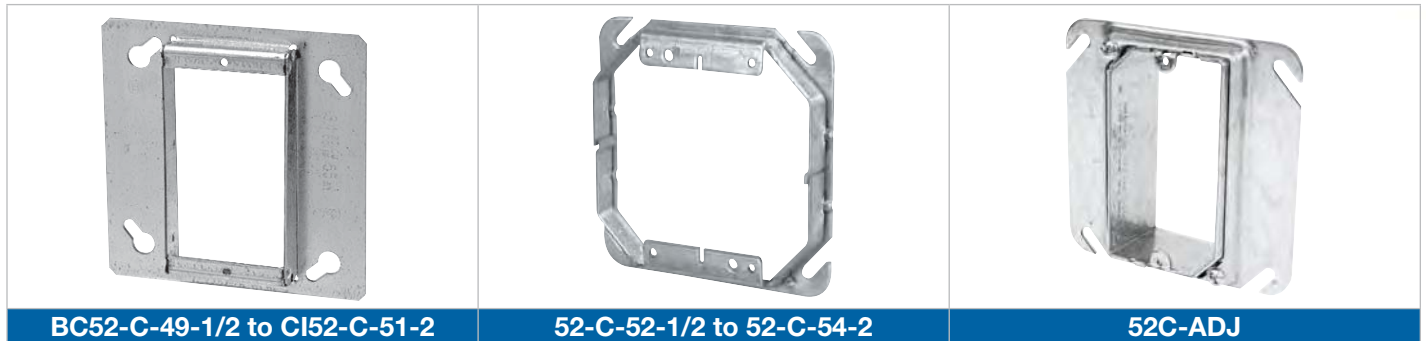

BC52-C-49-1/2 to CI52-C-51-2

52-C-52-1/2 to 52-C-54-2

52C-ADJ



Cat. No.	Description
One Device Square Cornered Tile Covers	
BC52-C-49-1/2	Raised 1/2 in. (3.4 cu. in.)
BC52-C-49-3/4	Raised 3/4 in. (5.3 cu. in.)
BC52-C-49-5/8	Raised 5/8 in. (4.3 cu. in.)
BC52-C-49-1	Raised 1 in. (6.8 cu. in.)
CI52-C-49-1-1/4	Raised 1-1/4 in. (8.6 cu. in.)
CI52-C-50-1-1/2	Raised 1-1/2 in. (10.0 cu. in.)
CI52-C-51-2	Raised 2 in. (14.0 cu. in.)
One Device Square Cornered Tile Covers - Adjustable	
52C-ADJ	Adjustable from 1/2 in. to 1-1/2 in. raise (from 3.4 to 10.0 cu. in.)
Two Device Square Cornered Tile Covers	
52-C-52-1/2	Raised 1/2 in. (6.0 cu. in.)
52-C-52-5/8	Raised 5/8 in. (8.3 cu. in.)
52-C-52-3/4	Raised 3/4 in. (9.0 cu. in.)
52-C-52-1	Raised 1 in. (12.5 cu. in.)
52-C-52-1-1/4	Raised 1-1/4 in. (15.5 cu. in.)
52-C-53-1-1/2	Raised 1-1/2 in. (19.0 cu. in.)
52-C-54-2	Raised 2 in. (25.5 cu. in.)