

Channels and Concrete Inserts

Welded Combinations

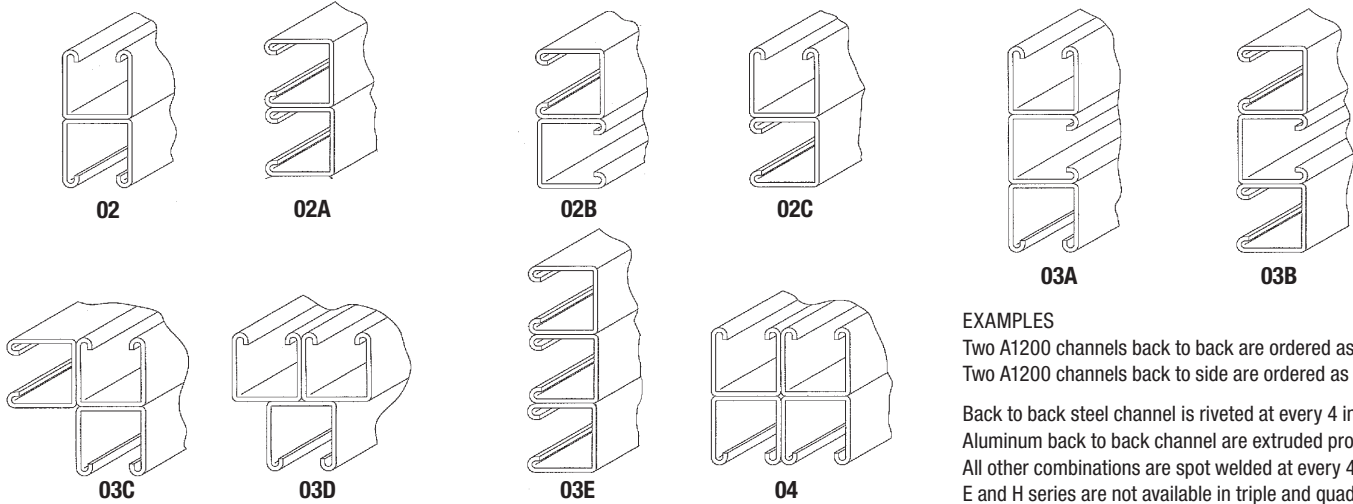

EXAMPLES

Two A1200 channels back to back are ordered as A1202.
Two A1200 channels back to side are ordered as A1202C.
Back to back steel channel is riveted at every 4 inches.
Aluminum back to back channel are extruded profiles.
All other combinations are spot welded at every 4 inches.
E and H series are not available in triple and quadruple.

End Caps and Closure Strips

A804 End Cap

RAWSEC End Cap for D1200 Channel

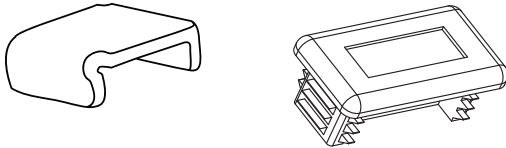

Cat. No.	For Channel	Wt./C lb.
A804EG	A1200	10
	A1400 AR1600	10
B804EG	B1400 BR1600	5
C804EG	C1200	8
E804EG	E1200	15
H804	H1400	20
RAWSEC	D1200	5 g (0.18 oz)

Safety End Cap

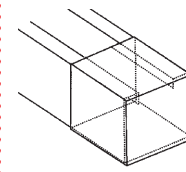

1-5/8 in. x 1-5/8 in. White Plastisol

Cat. No.	For Channel	Wt./C lb.
A804NEOPWH	A1200 AR1600	1.75
	A1400	
B804NEOPWH	B1200 BR1600	5
H804NEOPWH	H1200	2

A243-1EGC End Cap

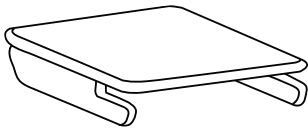

For A1200 Channel
Wt./C 16 lb.

A208

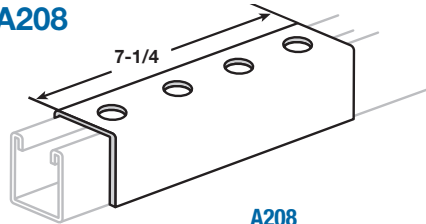

A208HDGC
A208EG

Does not include
stud nut or bolts.

A208
A208SS6C

Pour profilés
des séries A et AR.
Poids/100 : 275 lb

A213 Inside Joiner

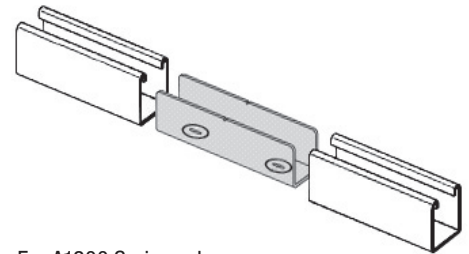

For A1200 Series only.
Available only in GoldGalv® finish.

Pre-Galvanized Steel Closure Strip

AB844PGC
AB844PGCWH
White Epoxy Powder Coated

Plastic Closure Strip

AB844PC Color : Gold
AB844PCGY Color : Grey

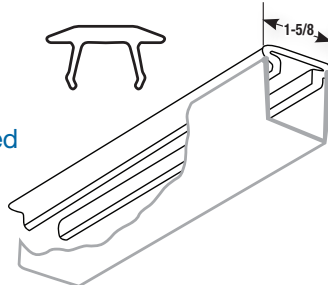

- When used as a raceway, channel is normally installed with the slot up. After wiring has been completed the closure strip is installed.
- For all channels.
- Standard length: 10 ft.

Stainless Steel Closure Strip

AB844SS6CS (Strapping not included)

