

## Overview

### Special Lugs for Special Problems — Angled, Shaped and Trimmed the Way You Need Them



Thomas & Betts can solve your difficult wire bending and terminating problems in confined power distribution panels, switchgear and motor control enclosures.

We have the design and production capability to deliver exactly the type lug you need, shaped the way you need.

- Straight, 15°, 30°, 45°, 60° and 90° angle
- Stacking or non-stacking
- Narrow tongue or standard
- Tin, silver, lead, nickel

Thomas & Betts offers an extensive line of copper Blackburn® lugs featuring the Color-Keyed® system for #8 AWG through 1000 kcmil flex and code cables. The lug tongues are modified in several different configurations to meet your exact needs: 45° and 90° bend angles, narrow tongues to fit into circuit breakers, offset tongues to stack two cables and special stud hole drilling. These special configurations let you:

- 1 Run cable directly to the bus bar with no bending.
- 2 Terminate into very narrow spaces.
- 3 Utilize minimal bus bar space.

The specially designed lugs help you “clean up” your cabling in crowded enclosures.

The photographs show some examples of how and where the lugs can be used.

### Customized Connectors for Copper Cables

- Standard and special tongue angles, stacking and non-stacking, bolt holes sizes and centers, protective platings.
- Specially modified one- and two-hole copper compression lugs, Series 54100, 54200, 54850BE and 54930BE for flex and code copper stranded cables. Material: High-conductivity wrought copper.
- Minimum order quantity: Standard package quantity by cable size. Consult factory for price and delivery. All customized lugs are made to order. A.R.O. Non-cancelable.



## Overview

### Order Form

Catalog No. \_\_\_\_\_ Qty. \_\_\_\_\_  
 (For 54100, 54200, 54800 & 54900 Series Copper Lugs Only)

### Design Controls and Requirements

All "MADE-UP" catalog numbers start with a standard or basic catalog number and are followed by the customer-required extra features: tongue shape, bolt hole size, distance between bolt holes, stacking, plating and inspection hole (peep hole). A code letter or a number has been assigned to each extra feature. See CODE TABLE.

- Notes:** 1) Lack of any of the extra features on the "MADE-UP" catalog number means that the standard Cat. No. features are prevalent.  
 2) If either bolt hole size or distance between bolt holes needs to be changed from standard Cat. No., both code numbers will appear on the "MADE-UP" Cat. No. (See example below)

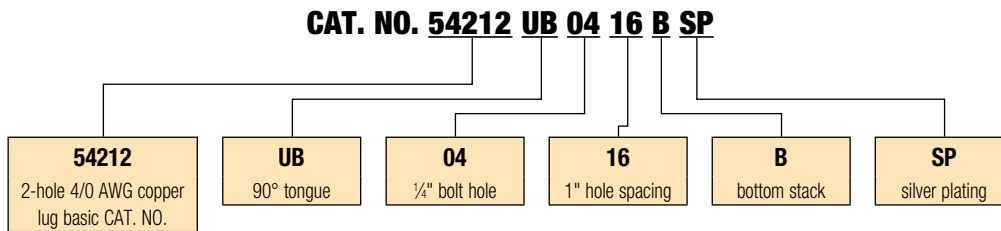

### Code Table

TONGUE SHAPE		BOLT HOLES		BOLT HOLE CENTERS		STACKING		FINISH (PLATING)		INSPECTION HOLE (LONG BARREL)		INSPECTION HOLE (SHORT BARREL)		
TYPE	CODE	SIZE	.020 CODE	DISTANCE	.015 CODE	TYPE	CODE	TYPE 1	CODE	I.D.	CODE	I.D.	CODE	
15°	UI	#8	.173	02	1/2"	08	Top	T**	Silver Plate	SP	Peep Hole	PH	Blind End	BE
30°	UT	#10	.204	03	5/8"	10	Bottom	B	Lead Plate	LP				
45°	UF	1/4"	.281	04	3/4"	12			Nickel Plate	NP				
60°	US	3/8"	.344	05	7/8"	14			Plain Finish	PF				
90°	UB	3/8"	.406	06	1"	16			No Marking	NM				
Blank	BT	1/2"	.531	08	1 1/8"	18			Not QTP if					
(No Bolt Hole)		5/8"	.656	10	1 1/4"	20			suffix other					
		3/4"	.812	12	1 3/8"	22			than - PF or					
		7/8"	.937	14	1 1/2"	24			standard					
		1"	1.062	16	1 5/8"	26			tin plate					
					1 3/4"	28								
					1 7/8**	30								
					2**	32								

\* These bolt centers not available for bolt holes larger than 1 1/8".

\*\* Not required for 45° & 90° top stacking.

Cable	Code	Weld
<input type="checkbox"/> #8	<input type="checkbox"/> #6	<input type="checkbox"/> #4
<input type="checkbox"/> #2	<input type="checkbox"/> #1	<input type="checkbox"/> 1/0
<input type="checkbox"/> 2/0	<input type="checkbox"/> 3/0	<input type="checkbox"/> 4/0
<input type="checkbox"/> 250 kcmil & up (Code Only)		

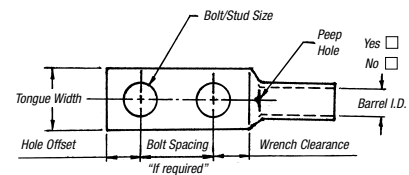
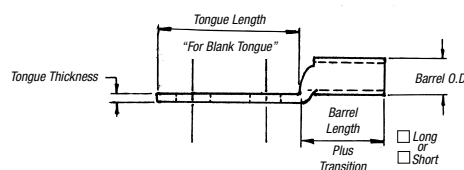

## Overview

### Tongue Specifications — See Chart “A” For Dimensions

Stud Sizes		
□ #8	□ #10	□ ¼"
□ ⅝"	□ ⅜"	□ ½"
□ ⅝"	□ ¾"	□ ⅞"
□ 1"		

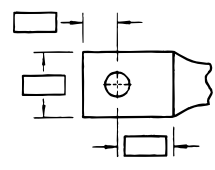

□ Single Hole

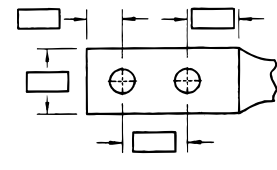

□ Double Hole

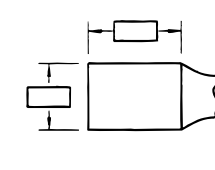

□ Blank

Chart A

NOMINAL BOLT HOLE SIZE .015	HOLE OFFSET .030	WRENCH CLEARANCE MIN.	TONGUE WIDTH CABLE SIZE										
			#8 CODE #8 WELD	#6 CODE #6 WELD	#4 CODE #4 WELD	#2 CODE #2 WELD	#1 CODE #1 WELD	1/0 CODE 1/0 WELD	2/0 CODE 2/0 WELD	3/0 CODE 3/0 WELD	4/0 CODE 4/0 WELD	250 CODE	
#8	.173	.200	.240	.406	.437	.562	.593	.672	.750	.825	.937	1.030	1.125
#10	.204	.218	.250	.406	.437	.562	.593	.672	.750	.825	.937	1.030	1.125
¼	.281	.250	.312	.469	.500	.562	.593	.672	.750	.825	.937	1.030	1.125
⅝	.344	.375	.406	.562	.562	.562	.675	.672	.750	.825	.937	1.030	1.125
⅜	.406	.375	.440	.578	.578	.594	.675	.672	.750	.825	.937	1.030	1.125
½	.531	.500	.562	—	—	—	.750	.750	.750	.825	.937	1.030	1.125
⅝	.656	.625	.875	—	—	—	—	—	—	—	.937	1.030	1.125
¾	.812	.750	.770	—	—	—	—	—	—	—	—	—	—
⅞*	.937	.875	.890	—	—	—	—	—	—	—	—	—	—
1*	1.062	.937	1.000	—	—	—	—	—	—	—	—	—	—

\* These bolt holes available in one-hole lug only.

Chart B

CABLE SIZE	TONGUE THICKNESS	STRAIGHT LUG BARREL LENGTH PLUS TRANSITION		BARREL		DIM "X" STACKED LUGS			DIM "Y"		DIM "H"	
		SHORT	LONG	O.D.	I.D.	STRAIGHT	45°	90°	SHORT	LONG	SHORT	LONG
#8	.080	.635	.935	.260	.180	.158	.478	.394	.595	.808	.779	1.079
#6	.081	.675	.975	.296	.215	.134	.544	.432	.587	.799	.767	1.067
#4	.099	.685	.985	.365	.266	.175	.622	.502	.637	.849	.838	1.138
#2	.108	.815	1.115	.410	.302	.216	.649	.535	.711	.923	.958	1.258
#1	.106	.825	1.275	.467	.361	.212	.731	.592	.710	1.028	.956	1.406
1/0	.125	.975	1.325	.520	.396	.250	.789	.646	.794	1.042	1.075	1.425
2/0	.125	.965	1.315	.571	.446	.250	.859	.696	.829	1.077	1.125	1.475
3/0	.125	1.085	1.435	.632	.507	.250	.946	.757	.900	1.148	1.225	1.575
4/0	.137	1.255	1.705	.701	.564	.274	1.031	.826	1.015	1.333	1.387	1.837
250	.137	1.375	1.925	.766	.629	.274	1.123	.891	1.085	1.474	1.487	2.037
300	.153	1.900	2.675	.850	.660	.459	1.226	.975	1.180	1.726	1.924	2.679
350	.177	2.090	2.896	.926	.720	.531	1.333	1.103	1.267	1.830	2.096	2.896
400	.173	2.460	2.980	.960	.757	.519	1.370	1.085	1.551	1.913	2.484	2.984
500	.218	2.670	3.610	1.100	.852	.654	1.514	1.225	1.629	2.266	2.669	3.619
600	.244	2.900	3.490	1.200	.926	.732	1.630	1.325	1.762	2.147	2.897	3.497
700	.228	2.784	—	1.255	.997	.684	1.662	1.375	1.780	—	3.011	—
750	.270	3.050	3.925	1.330	1.030	.810	1.745	1.455	1.827	2.434	3.050	3.925
800	.266	3.213	—	1.375	1.079	.800	1.728	1.625	1.952	2.787	3.213	4.554
900	.313	3.450	4.550	1.500	1.145	.940	1.900	1.650	2.065	—	1.387	—
1,000	.297	3.356	4.500	1.550	1.203	.890	2.070	1.675	2.031	2.787	1.487	4.506

Note: Stacking lugs are available for one bolt only.

Consult Factory: Straight: 700 kcmil & up.

45°: 400 kcmil & up

90°: 500 kcmil & up

## Overview

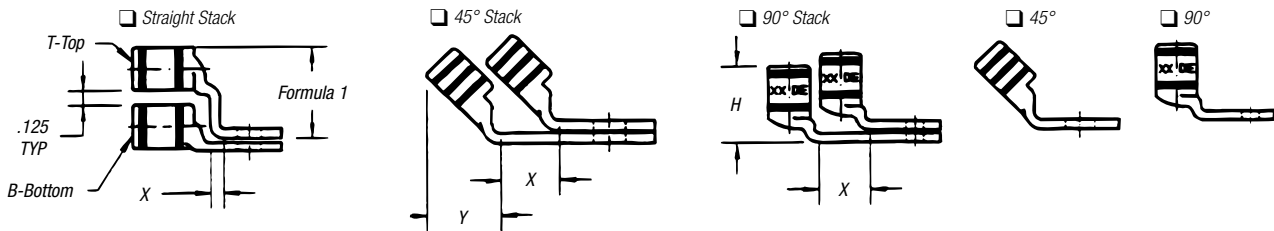

**Formula 1 = (.125 + 2 (OD) + .037 – Tongue Thickness)**

**Chart C**

BOLT HOLE SIZE	TONGUE WIDTH .030 CODE CABLE SIZE										
	300 KCMIL 4/0 WELD	350 KCMIL	400 KCMIL	500 KCMIL 400 WELD	600 KCMIL 500 WELD	1325/24	700 KCMIL	750 KCMIL	800 KCMIL	900 KCMIL	1000 KCMIL
#8	—	—	—	—	—	—	—	—	—	—	—
#10	—	—	—	—	—	—	—	—	—	—	—
¼	1.250	1.355	1.410	1.605	1.745	1.805	1.840	1.935	2.010	2.180	2.265
⅜	1.250	1.355	1.410	1.605	1.745	1.805	1.840	1.935	2.010	2.180	2.265
½	1.250	1.355	1.410	1.605	1.745	1.805	1.840	1.935	2.010	2.180	2.265
⅝	1.250	1.355	1.410	1.605	1.745	1.805	1.840	1.935	2.010	2.180	2.265
¾	1.250	1.355	1.410	1.605	1.745	1.805	1.840	1.935	2.010	2.180	2.265
7/8*	—	—	—	1.605	1.745	1.805	1.840	1.935	2.010	2.180	2.265
1*	—	—	—	—	1.745	1.805	1.840	1.935	2.010	2.180	2.265

\* These bolt holes available in one-hole lug only.

## Compression Connectors for Copper Conductor

### Two-Hole Lugs — 90° Long Barrel 600V to 35kV Applications

**Material:** High-Conductivity  
Wrought Copper

**Finish:** Electro Tin Plate



**Peep Holes Available!**  
Add suffix **-PH**

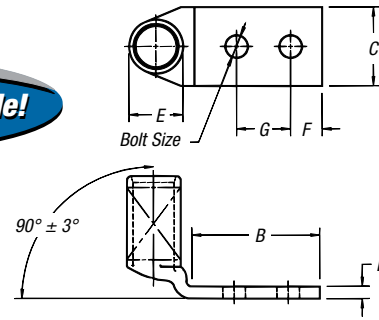

CAT. NO.	WIRE SIZE			DIMENSIONS (IN.)						DIE CODE	DIE COLOR	
	CODE	FLEX CLASS G, H, I, K, M <sup>1</sup>	BOLT SIZE	B	C	D	E	F	G			
56-31426-3SPHUB			#10	1.25	.37	.07	.20	7/32	5/8-3/4			
256-30695-1298UB	#14-10 AWG		1/4	1.22	.50	.05	.20	1/4	5/8	ERG4002, ERG4005		"C" NEST
256-30695-1055UB			1/4	1.31	.50	.13	.36	1/4	5/8-3/4			
54850BEUB		37/24 = 14.9 kcmil	1/4	1.89	.42	.07	.26	1/4	13/16	21		RED
54851BEUB	#8 AWG	#8 Weld	1/4	1.29	.47	.06	.26	1/4	3/4	21		
54851BEUB0616		23 Navy	3/8	2.10	.56	.06	.26	3/8	1	21		
54852BEUB			1/4	1.28	.44	.08	.30	1/4	5/8	24		BLUE
256306951014B		30 Navy	1/4	1.63	.43	.08	.30	1/4	1	24		
54852BEUB0412	#6 AWG	61/24 = 24.6 kcmil	1/4	1.43	.43	.08	.30	1/4	3/4	24		
54852BEUB0616		#6 Weld	3/8	1.93	.59	.06	.30	3/8	1	24		
54852BEUB0828			1/2	3.00	.88	.11	.30	1/2	1 1/4	24		
54854BEUB			1/4	1.19	.52	.10	.37	1/4	5/8	29		GRAY
54854BEUB0412		40-50 Navy	1/4	1.31	.56	.09	.37	1/4	3/4	29		
54854BEUB0416	#4 AWG	#5, 91/24 = 36.7 kcmil	1/4	1.88	.58	.09	.37	3/8	1	29		
54854BEUB0516		#4 Weld	5/16	1.75	.56	.10	.37	1 1/32	1	29		
54854BEUB0616			3/8	1.98	.59	.09	.37	3/8	1	29		
54854BEUB0828			1/2	3.00	.88	.09	.37	1/2	1 1/4	29		
54858BEUB0416			1/4	1.88	.67	.09	.41	3/8	1	33		BROWN
54855BEUB			1/4	1.28	.59	.11	.41	1/4	5/8	33		
54855BEUB0412		60 Navy	1/4	1.35	.68	.11	.41	1/4	3/4	33		
54856BEUB	#2-3 AWG	#3 Weld	5/16	1.63	.59	.11	.41	3/8	3/4	33		
54810BEUB		125/24 = 50.4 kcmil	3/8	2.57	.59	.11	.41	3/8	1 1/4	33		
54810BEUB0616			3/8	1.94	.59	.11	.41	3/8	1	33		
54811BEUB			1/2	3.00	.88	.11	.41	1/2	1 1/4	33		
54809BEUB			1/4	1.19	.67	.11	.47	1/4	5/8	37		GREEN
54812BEUB		75 Navy	1/4	1.40	.67	.11	.47	1/4	3/4	37		
54858BEUB	#1 AWG	150/24 = 60.5 kcmil	5/16	1.63	.67	.11	.47	3/8	7/8	37		
54857BEUB0616		175/24 = 70.6 kcmil	3/8	1.98	.67	.11	.47	3/8	1	37		
54857BEUB		#2 Weld	1/2	3.00	.88	.11	.47	1/2	1 1/4	37		
54859BEUB0416			1/4	1.88	.75	.13	.52	3/8	1	42		PINK
54859BEUB0416PH			1/4	1.88	.75	.13	.52	3/8	1	42		
54859BEUB		100 Navy	1/4	1.19	.75	.13	.52	1/4	5/8	42		
54813BEUB	1/0 AWG	#1 Weld	1/4	1.38	.75	.13	.52	1/4	3/4	42		
54860BEUB		225/24 = 90.8 kcmil	5/16	1.63	.75	.13	.52	3/8	7/8	42		
54860BEUB0616			3/8	1.98	.75	.13	.52	3/8	1	42		
54860BEUB0828			1/2	3.00	.75	.13	.52	5/8	1 1/4	42		
54814BEUB			1/4	1.25	.83	.13	.57	1/4	5/8	45		BLACK
54814BEUB0412		125 Navy	1/4	1.31	.81	.13	.57	1/4	3/4	45		
54862BEUB0616	2/0 AWG	275/24 = 111 kcmil	3/8	1.81	.83	.13	.57	3/8	1	45		
54862BEUB0616PH		1/0 Weld	3/8	1.81	.83	.13	.57	3/8	1	45		
54862BEUB			1/2	2.81	.83	.13	.57	1/2	1 1/4	45		

<sup>1</sup> Contact Technical Services for specific stranding listings

Tooling: pp. F-80-F-100 Die Selector Chart: pp. F-101-F-104