

Overview

The Thomas & Betts Method is Better.

The Thomas & Betts method of installing compression connectors on power cables is designed to provide a high degree of reliability in electrical wiring. This method allows electrical workers to make installations with little effort and at a considerable savings in time. The benefit, of course, is a high-quality connection at a low installed cost.

Just Four Easy Steps to a Perfect Connection!

Step 1

Carefully strip the insulation on de-energized wires to avoid nicking or cutting conductors (wire brush if required).

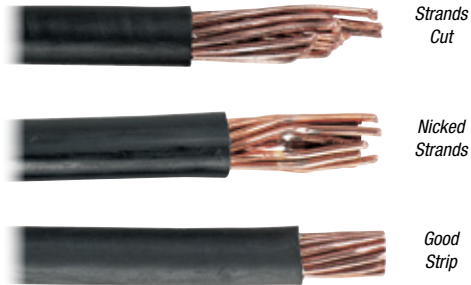

Strip the insulation to the proper length so that conductors can be fully inserted into the connector barrel.

Strip Length Too Long



Strip Length Too Short



Strip Length Just Right



Step 2

Determine the proper Blackburn® Connector for the cable size being used. Connectors are marked to show cable size.

- Connectors marked with just cable size or CU should be used on copper conductors only.
- Connectors marked "AL9"* with the cable size should be used on aluminum conductors only.
- Connectors marked "AL9CU" with the cable size may be used on the aluminum or copper conductors.

* Aluminum lugs with a "9" indicate 90° C rating.

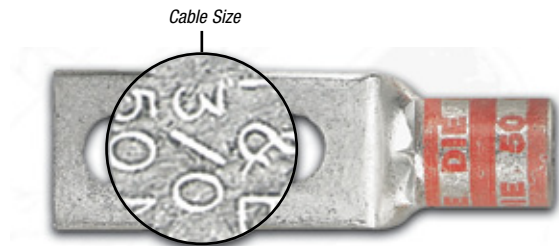

Overview

Step 3

Select the proper installing die and appropriate tool.

Blackburn® Connectors featuring the Color-Keyed® system have colored bands or colored dots that correspond to color markings on the dies.

Connectors and dies also have a die code number marked or stamped on them. Dies have a code number engraved in the crimp surface.

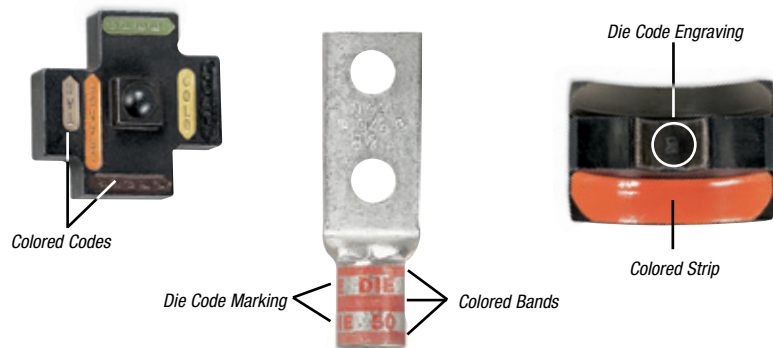

Step 4

Locate tool with correct die in proper position on connector and activate tool.

When making multiple crimps, make the first crimp nearest the tongue and work towards the barrel end.

When properly crimped, the die code number will be embossed on the connector for easy inspection to determine if correct die and connector combination were used.

Copper
Die located
BETWEEN bands



Aluminum
Die located
ON Bands



Die location for compression

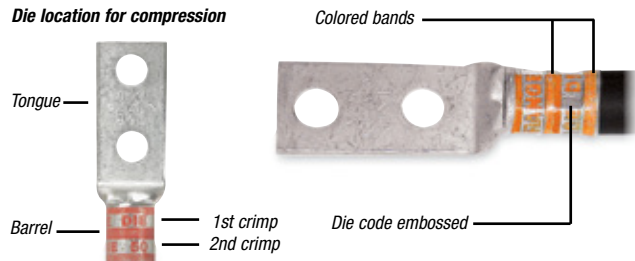

Blackburn® Connectors featuring the Color-Keyed® system are banded by colored stripes or engraving to indicate location of die on connector for compression.

Thomas & Betts uses full-width and half-width dies dependent on connector size and tool used. Half-width dies are marked with the letter "H" after the die code number.

Refer to the instruction sheet supplied with the connectors for information regarding strip length, die selection and number of compressions required.

Overview

Precision Dies Form a Solid Homogenous Mass...

The T&B method utilizing compression tools with matching dies forms the connector and conductor into a solid, homogenous mass to provide an optimum electrical bond between connector and conductor.

Thomas & Betts method dies are designed to produce a circumferential, hex- or diamond-shaped compression rather than a simple indent. Precision dies are an integral part of the Thomas & Betts method. The precision hardened steel dies exert tremendous, controlled pressure on the connector and conductor. The dies compress the connector around the cable, converting the round strands to hexagonal or diamond shapes and forming the strands and connector into a solid mass. Each die is designed so that all conductors receive the same amount of compression force.

The circumferential compression creates a large area of high-pressure contact between cable and connector which, in turn, assures high conductivity, low resistance, and high pullout values which exceed UL requirements. These features result in a permanent, low installed cost connection. You can install it, and forget it.



The Thomas & Betts System Tells You Where to Place the Installing Die.



Before compression, a typical cross section of cable and connector consists of about 75% metal and 25% air.

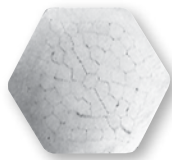

After air compression by the T&B Method, the cross section looks like this, nearly 100% metal with virtually no air spaces.

Blackburn® connectors featuring the Color-Keyed® system not only identify the correct installing die to be used for positive compressions, but also indicate the proper placement of the die on the connector. This is done by the bands of color on the connector which match the color on the dies. Compression is made between or on these color bands. The color name is also spelled on the connector as an added means of identification.

Thomas & Betts Dies Offer Inspection Capability.

Copper

Die located BETWEEN bands



Aluminum

Die located ON Bands



Dies that are used in Thomas & Betts hand and hydraulic tools contain the "die code" numbers which are engraved on the compression surface of the die. Under compression, this number becomes embossed on the completed connection for inspection purposes.

The inspector compares the die code number embossed on the connector with the die table to ensure that the proper connector was compressed with the correct die for that particular size conductor.



Blackburn® Connectors featuring the Color-Keyed® System are banded by colored stripes or engraving to indicate location of die on connector for compression.

Overview

Quality Tooling with the Shure-Stake® Mechanism

T&B manual tools with the exclusive Shure-Stake® mechanism take the guesswork out of making compression connections. The Shure-Stake® mechanism provides a full cycle compression stroke every time. Once the stroke has started, the tool will not release the connector until the proper amount of force has been applied. This is your assurance of a fully compressed connection. T&B compression tools develop uniform, controlled pressure to each connector within their size range. Thomas & Betts offers electric and battery-powered hydraulic pumps with a Shure-Stake® feature that guarantees a full cycle compression.



Battpac® LT Pump

The newest battery-powered hydraulic pump, rated for 10,000 psi. Portable power for all T&B hydraulic heads, using just one Ni-MH 24V rechargeable battery.



TBM62BSCR

Single-handed battery-powered compression tool, features rotating head and comfortable balance. For connectors up to 500 kcmil CU, 350 kcmil AL.



TBM6S

Hand-operated crimping tool features Shure-Stake® mechanism to ensure a completed crimp. For connectors up to 500 kcmil CU, 350 kcmil AL.

Thomas & Betts Method Components Meet Industry Standards.

Depending on the application, all Thomas & Betts copper connectors meet UL Std. 486A for code stranded and 24 gauge flex, CSA Std. C22.2, No. 65 600-Volt requirements for power and UL Std. 467, CSA Std. 22.2 No. 0.4 requirements for direct buried grounding.

T&B method connectors are available in a range of sizes and styles to accommodate #8 AWG through 1000 kcmil and larger copper or 2000 kcmil and larger aluminum cable. They may be compressed on cable with either manual or hydraulic tools. They are offered with standard length or long barrels, with one bolt or two bolt holes, or in two-way styles, for splicing applications. Two-way connectors are compact, providing high pullout values with low resistance.

Blackburn® two-hole lugs featuring the Color-Keyed® system are ideal for bus bar applications that require two bolts to prevent lug rotation.

The T&B method is the most efficient, highest quality connection that has been engineered and delivers the best electrical performance and highest reliability.

T&B Compression Connectors eliminate risk of problems relating to loose connections when installed properly.

High-Grade Materials Incorporated in Thomas & Betts Method.

Low installed cost connections of superior quality can be achieved only through the use of high-grade components. That is an important part of the T&B method — quality products you can depend on.

Copper Blackburn® connectors featuring the Color-Keyed® system are made of high-conductivity wrought copper, and are electro-tin plated to prevent corrosion and to improve conductivity. Thomas & Betts Blackburn® connectors featuring the Color-Keyed® system offer the thickest tin plating in the industry. Other copper connectors for heavy-duty use and grid grounding applications are made of high-conductivity cast copper, bright finished.

High-conductivity cast aluminum connectors are available for heavy-duty application.

Overview

Special Lugs for Special Problems — Angled, Shaped and Trimmed the Way You Need Them



Thomas & Betts can solve your difficult wire bending and terminating problems in confined power distribution panels, switchgear and motor control enclosures.

We have the design and production capability to deliver exactly the type lug you need, shaped the way you need.

- Straight, 15°, 30°, 45°, 60° and 90° angle
- Stacking or non-stacking
- Narrow tongue or standard
- Tin, silver, lead, nickel

Thomas & Betts offers an extensive line of copper Blackburn® lugs featuring the Color-Keyed® system for #8 AWG through 1000 kcmil flex and code cables. The lug tongues are modified in several different configurations to meet your exact needs: 45° and 90° bend angles, narrow tongues to fit into circuit breakers, offset tongues to stack two cables and special stud hole drilling. These special configurations let you:

- 1 Run cable directly to the bus bar with no bending.
- 2 Terminate into very narrow spaces.
- 3 Utilize minimal bus bar space.

The specially designed lugs help you “clean up” your cabling in crowded enclosures.

The photographs show some examples of how and where the lugs can be used.

Customized Connectors for Copper Cables

- Standard and special tongue angles, stacking and non-stacking, bolt holes sizes and centers, protective platings.
- Specially modified one- and two-hole copper compression lugs, Series 54100, 54200, 54850BE and 54930BE for flex and code copper stranded cables. Material: High-conductivity wrought copper.
- Minimum order quantity: Standard package quantity by cable size. Consult factory for price and delivery. All customized lugs are made to order. A.R.O. Non-cancelable.



Overview

Order Form

Catalog No. _____ Qty. _____
 (For 54100, 54200, 54800 & 54900 Series Copper Lugs Only)

Design Controls and Requirements

All "MADE-UP" catalog numbers start with a standard or basic catalog number and are followed by the customer-required extra features: tongue shape, bolt hole size, distance between bolt holes, stacking, plating and inspection hole (peep hole). A code letter or a number has been assigned to each extra feature. See CODE TABLE.

- Notes:** 1) Lack of any of the extra features on the "MADE-UP" catalog number means that the standard Cat. No. features are prevalent.
 2) If either bolt hole size or distance between bolt holes needs to be changed from standard Cat. No., both code numbers will appear on the "MADE-UP" Cat. No. (See example below)

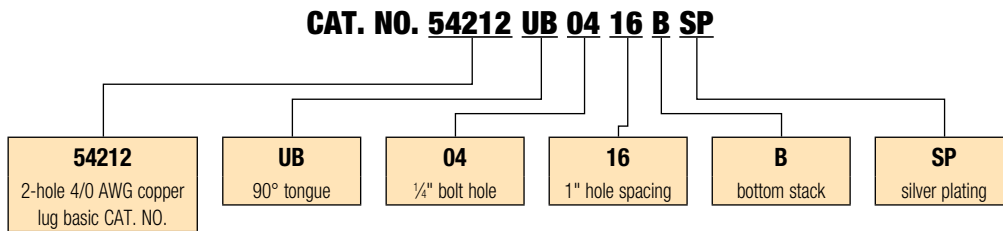

Code Table

TONGUE SHAPE		BOLT HOLES		BOLT HOLE CENTERS		STACKING		FINISH (PLATING)		INSPECTION HOLE (LONG BARREL)		INSPECTION HOLE (SHORT BARREL)		
TYPE	CODE	SIZE	.020 CODE	DISTANCE	.015 CODE	TYPE	CODE	TYPE 1	CODE	I.D.	CODE	I.D.	CODE	
15°	UI	#8	.173	02	1/2"	08	Top	T**	Silver Plate	SP	Peep Hole	PH	Blind End	BE
30°	UT	#10	.204	03	5/8"	10	Bottom	B	Lead Plate	LP				
45°	UF	1/4"	.281	04	3/4"	12			Nickel Plate	NP				
60°	US	3/8"	.344	05	7/8"	14			Plain Finish	PF				
90°	UB	3/8"	.406	06	1"	16			No Marking	NM				
Blank	BT	1/2"	.531	08	1 1/8"	18			Not QTP if					
(No Bolt Hole)		5/8"	.656	10	1 1/4"	20			suffix other					
		3/4"	.812	12	1 3/8"	22			than - PF or					
		7/8"	.937	14	1 1/2"	24			standard					
		1"	1.062	16	1 3/4"	26			tin plate					
					1 3/4"	28								
					1 7/8"	30								
					2"	32								

* These bolt centers not available for bolt holes larger than 1 1/8".

** Not required for 45° & 90° top stacking.

Cable	Code	Weld
<input type="checkbox"/> #8	<input type="checkbox"/> #6	<input type="checkbox"/> #4
<input type="checkbox"/> #2	<input type="checkbox"/> #1	<input type="checkbox"/> 1/0
<input type="checkbox"/> 2/0	<input type="checkbox"/> 3/0	<input type="checkbox"/> 4/0
<input type="checkbox"/> 250 kcmil & up (Code Only)		

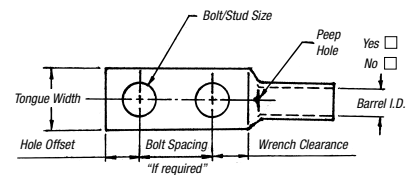
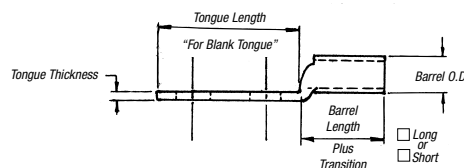

Overview

Tongue Specifications — See Chart “A” For Dimensions

Stud Sizes		
□ #8	□ #10	□ ¼"
□ ⅙"	□ ⅜"	□ ½"
□ ⅚"	□ ¾"	□ ⅞"
□ 1"		

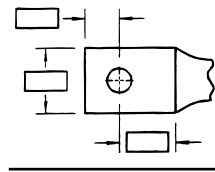

□ Single Hole

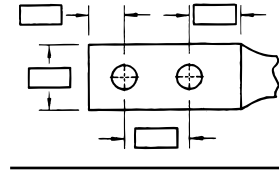

□ Double Hole

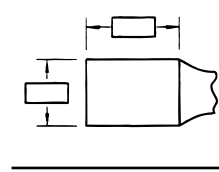

□ Blank

Chart A

NOMINAL BOLT HOLE SIZE .015	HOLE OFFSET .030	WRENCH CLEARANCE MIN.	TONGUE WIDTH CABLE SIZE										
			#8 CODE #8 WELD	#6 CODE #6 WELD	#4 CODE #4 WELD	#2 CODE #2 WELD	#1 CODE #1 WELD	1/0 CODE 1/0 WELD	2/0 CODE 2/0 WELD	3/0 CODE 3/0 WELD	4/0 CODE 4/0 WELD	250 CODE	
#8	.173	.200	.240	.406	.437	.562	.593	.672	.750	.825	.937	1.030	1.125
#10	.204	.218	.250	.406	.437	.562	.593	.672	.750	.825	.937	1.030	1.125
¼	.281	.250	.312	.469	.500	.562	.593	.672	.750	.825	.937	1.030	1.125
⅙	.344	.375	.406	.562	.562	.562	.675	.672	.750	.825	.937	1.030	1.125
⅜	.406	.375	.440	.578	.578	.594	.675	.672	.750	.825	.937	1.030	1.125
½	.531	.500	.562	—	—	—	.750	.750	.750	.825	.937	1.030	1.125
⅝	.656	.625	.875	—	—	—	—	—	—	—	.937	1.030	1.125
¾	.812	.750	.770	—	—	—	—	—	—	—	—	—	—
⅞*	.937	.875	.890	—	—	—	—	—	—	—	—	—	—
1*	1.062	.937	1.000	—	—	—	—	—	—	—	—	—	—

* These bolt holes available in one-hole lug only.

Chart B

CABLE SIZE	TONGUE THICKNESS	STRAIGHT LUG BARREL LENGTH PLUS TRANSITION		BARREL		DIM "X" STACKED LUGS			DIM "Y"		DIM "H"	
		SHORT	LONG	O.D.	I.D.	STRAIGHT	45°	90°	SHORT	LONG	SHORT	LONG
#8	.080	.635	.935	.260	.180	.158	.478	.394	.595	.808	.779	1.079
#6	.081	.675	.975	.296	.215	.134	.544	.432	.587	.799	.767	1.067
#4	.099	.685	.985	.365	.266	.175	.622	.502	.637	.849	.838	1.138
#2	.108	.815	1.115	.410	.302	.216	.649	.535	.711	.923	.958	1.258
#1	.106	.825	1.275	.467	.361	.212	.731	.592	.710	1.028	.956	1.406
1/0	.125	.975	1.325	.520	.396	.250	.789	.646	.794	1.042	1.075	1.425
2/0	.125	.965	1.315	.571	.446	.250	.859	.696	.829	1.077	1.125	1.475
3/0	.125	1.085	1.435	.632	.507	.250	.946	.757	.900	1.148	1.225	1.575
4/0	.137	1.255	1.705	.701	.564	.274	1.031	.826	1.015	1.333	1.387	1.837
250	.137	1.375	1.925	.766	.629	.274	1.123	.891	1.085	1.474	1.487	2.037
300	.153	1.900	2.675	.850	.660	.459	1.226	.975	1.180	1.726	1.924	2.679
350	.177	2.090	2.896	.926	.720	.531	1.333	1.103	1.267	1.830	2.096	2.896
400	.173	2.460	2.980	.960	.757	.519	1.370	1.085	1.551	1.913	2.484	2.984
500	.218	2.670	3.610	1.100	.852	.654	1.514	1.225	1.629	2.266	2.669	3.619
600	.244	2.900	3.490	1.200	.926	.732	1.630	1.325	1.762	2.147	2.897	3.497
700	.228	2.784	—	1.255	.997	.684	1.662	1.375	1.780	—	3.011	—
750	.270	3.050	3.925	1.330	1.030	.810	1.745	1.455	1.827	2.434	3.050	3.925
800	.266	3.213	—	1.375	1.079	.800	1.728	1.625	1.952	2.787	3.213	4.554
900	.313	3.450	4.550	1.500	1.145	.940	1.900	1.650	2.065	—	1.387	—
1,000	.297	3.356	4.500	1.550	1.203	.890	2.070	1.675	2.031	2.787	1.487	4.506

Note: Stacking lugs are available for one bolt only.

Consult Factory: Straight: 700 kcmil & up.

45°: 400 kcmil & up

90°: 500 kcmil & up

Overview

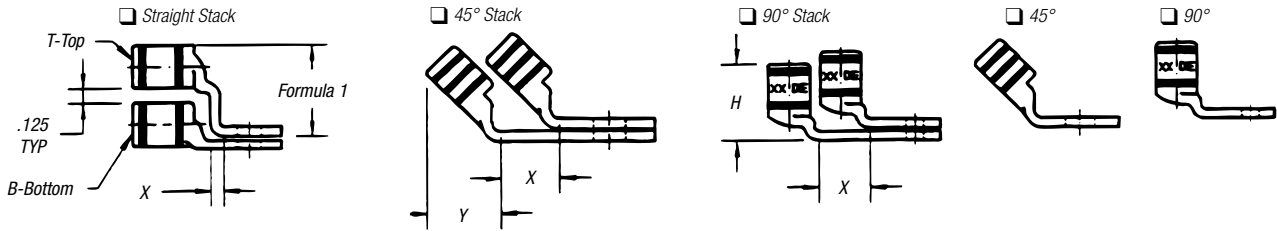

Formula 1 = (.125 + 2 (OD) + .037 – Tongue Thickness)

Chart C

BOLT HOLE SIZE	TONGUE WIDTH .030 CODE CABLE SIZE										
	300 KCMIL 4/0 WELD	350 KCMIL	400 KCMIL	500 KCMIL 400 WELD	600 KCMIL 500 WELD	1325/24	700 KCMIL	750 KCMIL	800 KCMIL	900 KCMIL	1000 KCMIL
#8	—	—	—	—	—	—	—	—	—	—	—
#10	—	—	—	—	—	—	—	—	—	—	—
¼	1.250	1.355	1.410	1.605	1.745	1.805	1.840	1.935	2.010	2.180	2.265
⅜	1.250	1.355	1.410	1.605	1.745	1.805	1.840	1.935	2.010	2.180	2.265
½	1.250	1.355	1.410	1.605	1.745	1.805	1.840	1.935	2.010	2.180	2.265
⅝	1.250	1.355	1.410	1.605	1.745	1.805	1.840	1.935	2.010	2.180	2.265
¾	1.250	1.355	1.410	1.605	1.745	1.805	1.840	1.935	2.010	2.180	2.265
7/8*	—	—	—	1.605	1.745	1.805	1.840	1.935	2.010	2.180	2.265
1*	—	—	—	—	1.745	1.805	1.840	1.935	2.010	2.180	2.265

* These bolt holes available in one-hole lug only.

Compression Connectors for Copper Conductor

Two-Hole Lugs — Standard Barrel 600V to 35kV

Material: High-Conductivity Wrought Copper
Finish: Electro Tin Plate

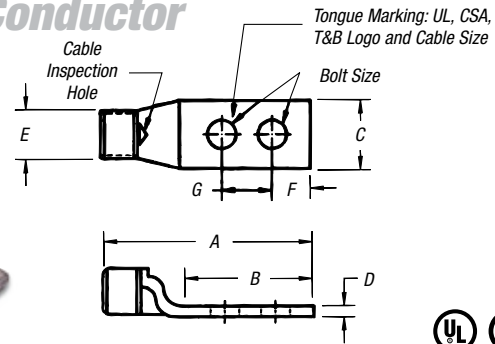

Connectors & Grounding — Blackburn® Compression Connectors Featuring the Color-Keyed® System

CAT. NO.	WIRE SIZE				DIMENSIONS (IN.)							DIE CODE	DIE COLOR
	CODE	FLEX CLASS G, H, I, K, M†	BOLT SIZE		A	B	C	D	E	F	G		
54201			¼	1.86	1.19	.50	.05	.20	¼	⅝	ERG4002,	"C" NEST	
256-30695-1302	#14-10 AWG		⅜	2.48	1.81	.56	.04	.22	⅝	1	ERG4005		
54204			#10	1.88	1.18	.42	.08	.26	¼	⅝	21	RED	
256-31426-33*			#10	1.88	1.18	.41	.06	.26	⅜	⅝-¾	21		
256-31426-33PH	8 AWG	23 Navy	#10	1.88	1.18	.41	.06	.26	⅜	⅝-¾	21		
542040410	#7 LS	#8 Weld	¼	2.01	1.31	.42	.08	.26	¼	⅝	21		
542040416		37/24 = 14.9 kcmil	¼	2.38	1.68	.42	.08	.26	¼	1	21		
256-30695-1094			¼	2.50	1.81	.56	.05	.26	¼	¾	21		
256-30695-251			⅝	2.50	1.81	.56	.05	.26	⅝	1	21	BLUE	
256-30695-1070			#12	1.81	1.19	.44	.11	.30	¼	½-⅝	24		
256-30695-1153			#10	1.98	1.28	.44	.08	.30	¼	½	24		
256-30695-1183		30 Navy	#10	1.98	1.19	.44	.08	.30	⅜	⅝-¾	24		
54205		#6 Weld	¼	1.98	1.28	.44	.08	.30	¼	⅝	24		
256-30695-1095	#6 AWG	61/24 = 24.6 kcmil	¼	2.13	1.31	.43	.08	.30	¼	¾	24		
256-30695-252		133/.014	¼	2.38	1.63	.43	.08	.30	¼	1	24		
256-30695-372		#5 Weld	¼	2.13	1.43	.43	.08	.30	¼	¾	24		
256-30695-913			¼	2.38	1.75	.43	.08	.30	¼	1	24		
256-30695-253			⅝	2.58	1.81	.55	.08	.30	⅝	1	24		
54206		40-50 Navy, #4 Weld	¼	2.03	1.28	.52	.10	.37	¼	⅝	29	GRAY	
256-30695-1184	#4 AWG	#5, 91/24 = 36.7 kcmil	⅝	2.31	1.63	.52	.10	.37	⅝	1	29		
256-30695-255		133/.0177, 49/.029	⅝	2.56	1.81	.59	.09	.37	⅝	1	29		
54207			¼	2.13	1.28	.59	.11	.41	¼	⅝	33	BROWN	
256-30695-1355		#3 Flex	¼	2.15	1.31	.59	.13	.41	¼	¾	33		
256-30695-1185	#3 AWG	60 Navy	¼	2.38	1.53	.59	.11	.41	¼	1	33		
256-30695-257	#2 AWG	125/24 = 50.4 kcmil	½	2.67	1.81	.60	.1	.41	⅝	1	33		
256-30695-1049			½	3.75	2.88	.75	.09	.41	⅝	1¾	33		
54208		75 Navy, #2 Weld	¼	2.13	1.28	.68	.11	.47	¼	⅝	37	GREEN	
256-30695-1233	#1 AWG	150/24 = 60.5 kcmil	⅝	2.69	1.62	.69	.13	.47	1½/32	1	37		
256-30695-1236		175/24 = 70.6 kcmil, 133/.0223	⅝	2.75	1.81	.68	.11	.47	⅝	1	37	PINK	
256-30695-329			¼	2.75	1.81	.75	.14	.52	⅝	¾	42		
54255		100 Navy	⅝	2.56	1.56	.75	.14	.52	⅝	⅞	42		
256-30695-1234	1/0 AWG	#1 Weld	⅝	2.75	1.78	.75	.14	.52	⅜	1	42		
54209		225/24 = 90.8 kcmil	⅝	2.88	1.93	.75	.13	.52	⅝	1	42		
256-30695-1265		133/.0254	⅝	3.50	2.57	.75	.14	.52	⅝	1¾	42		
256-30695-886			½	3.78	2.83	.75	.13	.52	½	1¾	42	BLACK	
256-30695-1175			¼	2.45	1.44	.83	.14	.57	¼	¾	45		
54261		125 Navy	⅝	2.70	1.63	.83	.14	.57	⅜	⅞	45		
256-30695-832	2/0 AWG	1/0 Weld	⅝	2.88	1.81	.81	.14	.57	⅝	1	45		
54210		275/24 = 111 kcmil	⅝	2.93	1.93	.83	.13	.57	⅝	1	45		
54260		133/.0282	½	3.83	2.81	.83	.14	.57	⅝	1¾	45	ORANGE	
54266		150 Navy, 2/0 Weld	⅝	2.88	1.75	.94	.14	.63	⅜	1	50		
54211	3/0 AWG	325/24 = 131 kcmil	⅝	2.94	1.81	.94	.14	.63	⅝	1	50		
54265		133/.0316, 259/.0227, 427/.0177	½	3.94	2.81	.94	.14	.63	½	1¾	50		

† Contact Technical Services for specific stranding listings

Tooling: pp. F-80-F-100 Die Selector Chart: pp. F-101-F-104 * Blind End