

## Pipe Straps, Conduit Clamps and Hangers

### C-725 — Two-Bolt Pipe Clamp

Designed to suspend cold or hot pipe lines where little or no insulation is required. The C-725 is usually used with an E-120-A Weldless Eyerut or E-157 Welded Eyerod. See Figure 298 heavy-duty Two-Bolt Clamp when higher loads are required. We will also design to meet special requirements such as special pipe sizes.

Rated Loads are for up to 750° F (399° C).

#### Specifications

- Material: Carbon Steel
- Compliance: Federal Specification A-A-1192A Type 4, MSS-SP-69 Type 4 and BSPSS-BS3974
- Finish: Standard Finish – GoldGalv®, Black (add suffix “-B”), Electro-Galvanized (add suffix “-EG”)
- Ordering: Specify catalog number, finish and pipe size. Also, include any special requirements for C-725

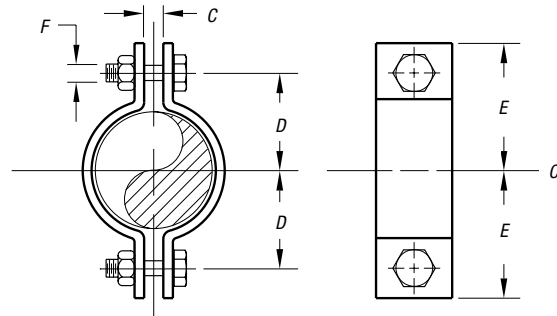

C-726

CAT. NO.	PIPE SIZE (IN.)	MAXIMUM LOAD		C (IN.)	ROD TAKE OUT D (IN.)	E (IN.)	F (IN.)	WT. EACH (LBS.)
		650° F/343° C	750° F/343° C					
C725 1/2	1/2	500	445	3/8	1 1/8	1 1/8	3/8	.31
C-725-3/4	3/4	500	445	3/8	1 1/4	1 3/4	3/8	.35
C-725-1	1	500	445	3/8	1 3/8	1 7/8	3/8	.39
C-725-1-1/4	1 1/4	500	445	3/8	1 7/8	2 1/8	3/8	.40
C-725-1-1/2	1 1/2	800	715	3/8	1 3/4	2 1/4	3/8	.45
C-725-2	2	1,040	930	1/2	2 1/8	2 3/8	1/2	1.23
C-725-2-1/2	2 1/2	1,040	930	5/8	2 3/8	3 1/8	1/2	1.33
C-725-3	3	1,040	930	5/8	3	3 1/2	1/2	1.53
C-725-4	4	1,040	930	3/4	3 3/8	4 1/8	1/2	2.20
C-725-5	5	1,040	930	3/4	4 1/4	5	1/2	2.39
C-725-6	6	1,615	1,440	7/8	5 1/4	6 1/4	3/4	5.87
C-725-8	8	1,615	1,440	1	6 3/8	7 3/8	3/4	6.95
C-725-10	10	2,490	2,220	1	7 3/8	8 3/4	7/8	14.39
C-725-12	12	2,490	2,220	1 1/8	8 3/4	10 1/4	7/8	16.73
C-725-14	14	2,490	2,220	1 1/8	9 1/4	10 3/8	7/8	21.26
C-725-16	16	2,490	2,220	1 1/8	10 1/4	11 1/8	7/8	23.39
C-725-18	18	3,060	2,730	1 1/4	11 1/8	13	1	32.96
C-725-20	20	3,060	2,730	1 3/8	12 3/4	14 1/8	1 1/8	36.74
C-725-24	24	3,060	2,730	1 1/2	15 1/4	16 3/8	1 1/8	52.96
C-725-30	30	3,500	3,360	2	18 1/2	20 3/4	1 1/2	103.50

Standard Finish – GoldGalv®, unless otherwise stated.

## Special Metals and Finishes

### Type 304 Stainless Steel Products (SS Suffix) (continued)

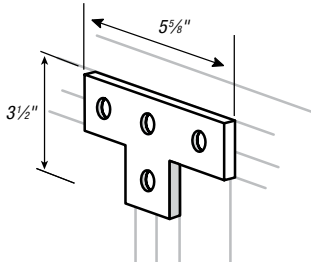

AB220

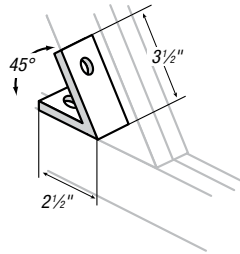

AB225

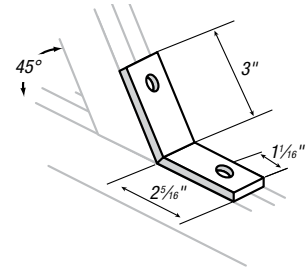

SPAB-227

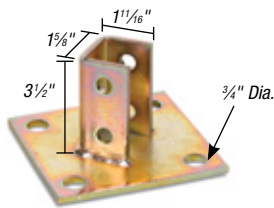

AP-232

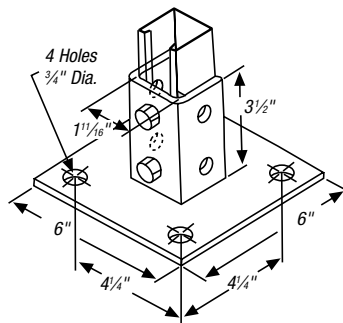

AP-232SQ

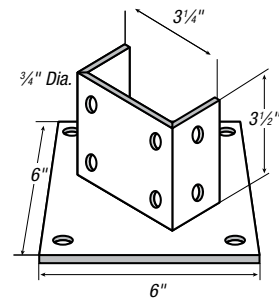

AP-235

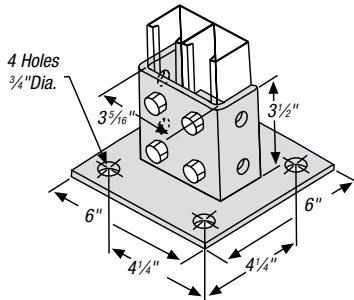

AP-235SQ

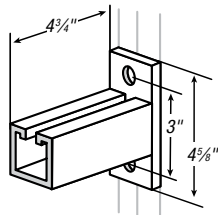

S-250

A is in lengths: 6, 12, 18 & 24.  
May be installed inverted with no change  
in load ratings. Strut section made from  
half slot channel.

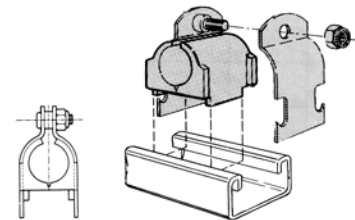

A-716  
Cushioned Clamp Tube Series

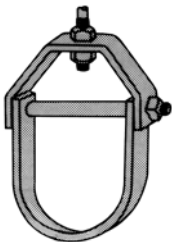

C-710 Series  
Standard Clevis

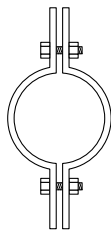

C-720

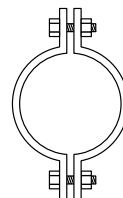

C-725



C-727  
Standard Ring Hanger

## Technical Information

### Federal Specifications (WW-H-171)/ Manufacturers Society Specifications (MSS SP69)



**C-710**  
Adj. Steel Clevis  
Sizes 3/4" through 20" IPS  
**Federal Type 1**  
**SP69 Type 1**



**C-726**  
Steel Double Bolt Pipe Clamp  
Sizes 1 1/2" through 24" IPS  
**Federal Type 3**  
**SP69 Type 3**



**C-725**  
Steel Pipe Clamp  
Sizes 1 1/2" through 24" IPS  
**Federal Type 4**  
**SP69 Type 4**



**CF-710**  
Adj. Steel Band Hanger  
Sizes 1/2" through 8"  
IPS 3/4" through 4" tube  
**Federal Type 7**

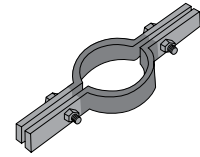

**C-720/CT-720**  
Extension Pipe or Riser Clamp  
Sizes 3/4" through 20"  
IPS 1/2" through 6" tube  
**Federal Type 8**  
**SP69 Type 8**



**C-727/CT-727**  
Adj. Swivel Ring Hanger  
Sizes 1/2" through 8" IPS  
1/2" through 4" tube  
**Federal Type 10**  
**SP69 Type 10**

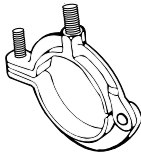

**M-718/MT-718**  
MI Split Pipe Ring  
w/wo turnbuckle adj.  
Sizes 1/2" through 8" IPS  
1/2" through 4" tube  
**Federal Type 11**  
**SP69 Type 12**



**CL-710**  
Light-Duty Clevis Hanger  
Sizes 1/2" through 4"  
**Federal Type 12**



**F-112**  
Forged Steel Turnbuckle  
Sizes 3/8" through 1 1/2" rod  
**Federal Type 13**  
**SP69 Type 13**



**F-111**  
Forged Steel Clevis  
Sizes 3/8" through 1 1/2" rod  
**Federal Type 14**  
**SP69 Type 13**

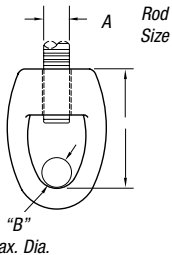

**M-117**  
MI Socket only for  
S Split Ring Hanger  
Sizes 3/8" through 1 1/2" Rod  
**Federal Type 16**  
**SP69 Type 16**



**E-120-A**  
Forged Steel Weldless Eye Nut  
Sizes 3/8" through 1 1/2" rod  
**Federal Type 17**  
**SP69 Type 17**

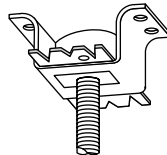

**452**  
Steel Concrete Insert  
**Federal Type 19**  
**SP69 Type 18**

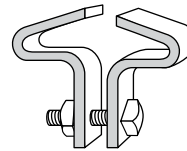

**C-755 T/C-757 T**  
Center I-Beam Clamp  
**Federal Type 21**  
**SP69 Type 21**

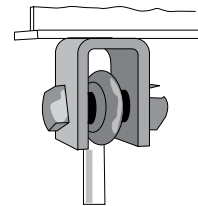

**C-780**  
Welded attachment as  
shown or inverted less bolt  
**Federal Type 22**  
**SP69 Type 22**



**M-775-L/C-775-L**  
MI or Steel C-Clamp  
Sizes 3/8" through 1 1/2"  
**Federal Type 23**  
**SP69 Type 23**



**H-115**  
U-Bolt  
Sizes 1/2" through 24" IPS  
**Federal Type 24**  
**SP69 Type 24**

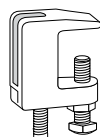

**M-778**  
Top Beam C-Clamp  
Sizes 3/8" through 3/4" rod  
**SP69 Type 19**

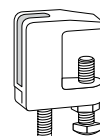

**M-777**  
Junior Top Beam C-Clamp  
Sizes 3/8" through 1/2" rod  
**SP69 Type 18**

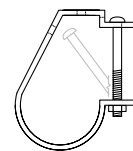

**C-711**  
"J" Pipe Hanger  
Sizes 1/2" through 8" pipe  
**SP69 Type 5**