

Features and Benefits

UL 1686 C1 Insulgrip® Pin and Sleeve Devices

With the introduction of UL standard 1686-C1, configurations are uniform throughout the industry. That means Hubbell—the name that sets the standard for pin and sleeve performance, reliability, durability, innovation and ease of use—can finally become your standard. Hubbell's new line of heavy duty Insulgrip® Pin and Sleeve wiring devices not only offers complete interchangeability, it delivers the goods when it comes to superior design and construction. Hubbell Insulgrip Pin and Sleeve devices are engineered and built to handle today's most demanding work environments, making Hubbell the unsurpassed heavyweight in the heavy duty market.

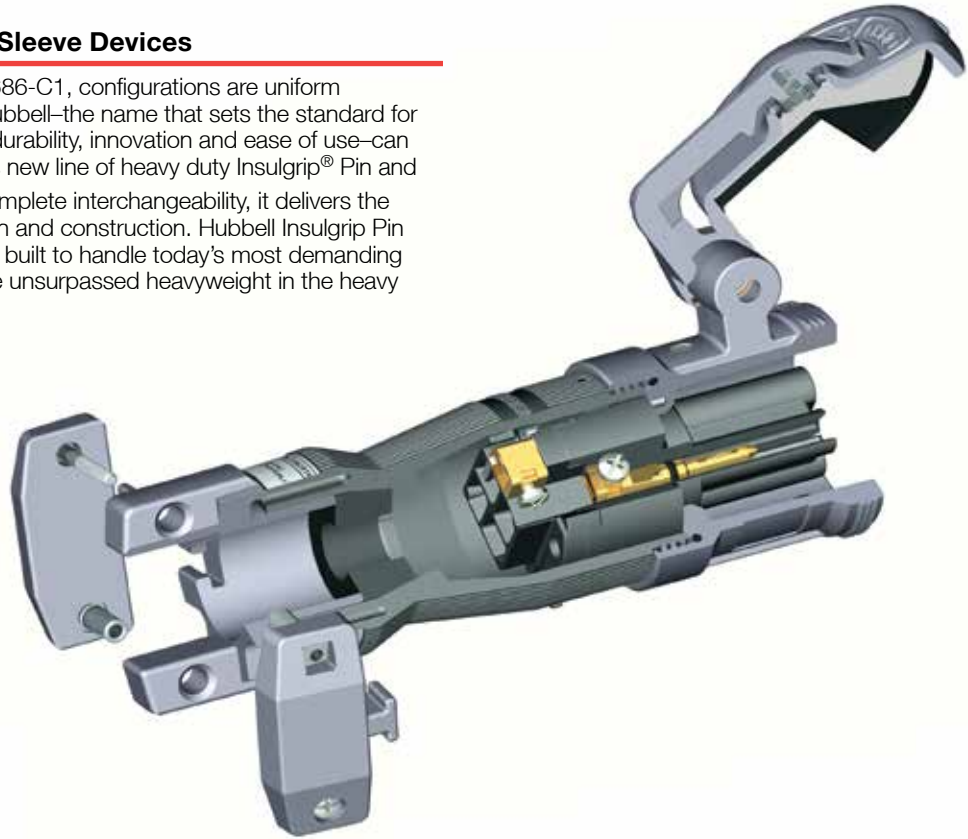

Housing Design

- Thermoplastic housing provides excellent insulating, impact, corrosion, and UV resistant properties. Protects users and internal components in the roughest of environments
- Spring-loaded, gasketed cover provides a UL Type 4X watertight, dust-tight seal on connectors and receptacles

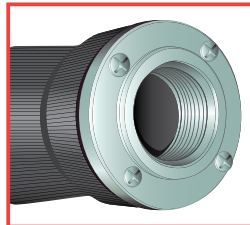

Liquidtight Conduit Adapters

- Machined aluminum adapters are available to provide a means for attaching flexible liquidtight metal conduit to rear of Hubbell Pin and Sleeve plug or connector



Powerful Mechanical Cord Grip

- Hubbell's design incorporates two molded-in teeth to securely grip the outer cable jacket, and internal conductors to prevent slippage and strain on terminations
- Captive barrel nuts ease assembly and allow higher tightening torque for maximum cord retention



Terminal Entrance Holes

- Large, square funneled entrance holes isolate each conductor to protect against shorts due to stray conductor strands
- Tapered hole provides a fast and easy guide into the termination chamber
- Pin chamber confines arcing within the interior chamber during make and break cycle of mating devices, minimizes arc tracking

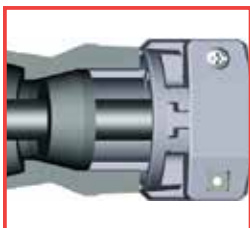

Watertight Cord Entrance

- The tapered bore entrance creates high compression forces on sealing gland, providing a watertight seal around cord
- Individual solid neoprene glands are supplied to match a full range of cord sizes and assure watertight performance



Anti-Vibration Box Terminals

- Interlocking box terminals ensure that terminal screws remain secure and cannot loosen
- The floating box is designed to obtain high-torque values without damaging stranded conductors

Features and Benefits

UL 1686 C1 Insulgrip® Pin and Sleeve Devices

Metallic where you want it, non-metallic where you need it. Different from traditional all-metallic devices, Hubbell Pin and Sleeve wiring devices are designed to provide metallic shrouding where you want it and a non-metallic housing where you need it.

What's more, Hubbell's new watertight Insulgrip Pin and Sleeve wiring devices are designed with safety first and foremost. We created the line with plant facility maintenance personnel and a safer industrial work environment in mind. To greatly reduce the likelihood of electrical shock, we developed our exclusive nonmetallic watertight system, meaning that with Hubbell on the job, the mix of electricity and water isn't the threat it once was. So, whether the job calls for a welding outlet in a dry location or a motor disconnect in a wet location, step up to Hubbell Pin and Sleeve wiring devices.

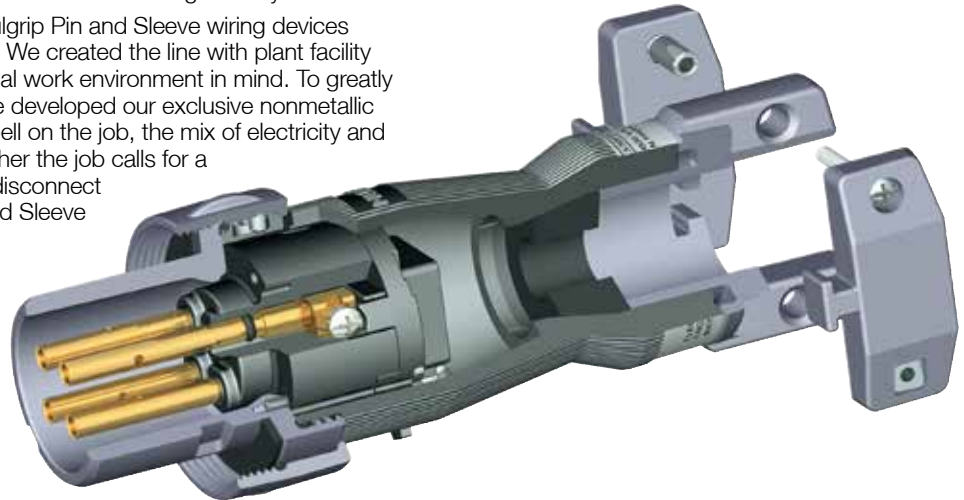

Housing Design

- Thermoplastic housing provides excellent insulating, impact, corrosion, and UV resistant properties. Protects users and internal components in the roughest of environments
- Locking ring provides a UL Type 4X watertight and dust-tight seal when the male and female devices are connected

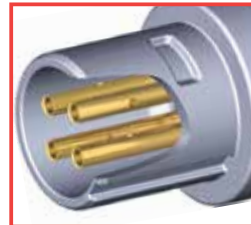

Shrouded Sleeves

- Housing seal provides a watertight and dust-tight seal when mated with receptacle or connector
- Protects the user from the possibility of touching live contacts during insertion and withdrawal of mating parts
- Shrouded sleeves protects contact sleeves from deforming from physical abuse



Interior Design

- Sleeve O-ring seal provides a watertight and dust-tight seal around the sleeves. Assures that contamination will not enter wire chamber
- All-brass sleeve contacts provide reliable electrical contact with mating pins, also with minimum heat build-up over time



Thermoset Polyester Contact Carrier

- Molded thermoset polyester provides high resistance to electrical tracking
- Withstands higher temperatures which may result from overload or arcing
- Thermoset properties provide dimensional stability for this critical assembly



Product Marking

- Catalog number and rating visible while in use. Markings are color coded differentiating Style I and Style II devices

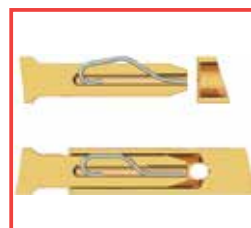

























Beryllium Copper Spring-Pin Design (Patented)





- Maintains high unit pressure on mating sleeves. Ensures reliable electrical contact while minimizing heat rise due to normal pin wear over time

Pin and Sleeve Devices/Mechanical Interlocks



TYPE 4X**

Rating				"Reversed Service" Style I Devices			Replacement Interiors	
Amps	Poles and Wires	Receptacle/ Connector Configuration*	Maximum Voltage AC/DC	 Receptacle	 Plug	 Connector	 Connector & Receptacle	 Plug
30	2P 3W		600/250	HBL330RS1WR	HBL330PS1WR	HBL330CS1WR	IN330MS1	IN330FS1
	3P 4W		600/250	HBL430RS1WR	HBL430PS1WR	HBL430CS1WR	IN430MS1	IN430FS1
	4P 5W		600/250	HBL530RS1WR	HBL530PS1WR	HBL530CS1WR	IN530MS1	IN530FS1
60	2P 3W		600/250	HBL360RS1WR	HBL360PS1WR	HBL360CS1WR	IN360MS1	IN360FS1
	3P 4W		600/250	HBL460RS1WR	HBL460PS1WR	HBL460CS1WR	IN460MS1	IN460FS1
	4P 5W		600/250	HBL560RS1WR	HBL560PS1WR	HBL560CS1WR	IN560MS1	IN560FS1
100	2P 3W		600/250	HBL3100RS1WR	HBL3100PS1WR	HBL3100CS1WR	IN3100MS1	IN3100FS1
	3P 4W		600/250	HBL4100RS1WR	HBL4100PS1WR	HBL4100CS1WR	IN4100MS1	IN4100FS1
	4P 5W		600/250	HBL5100RS1WR	HBL5100PS1WR	HBL5100CS1WR	IN5100MS1	IN5100FS1
200	3P 4W		600/250	HBL4200RS1WR	HBL4200PS1WR	HBL4200CS1WR	IN4200MS1†	IN4200FS1†
	4P 5W		600/250	HBL5200RS1WR	HBL5200PS1WR	HBL5200CS1WR	IN5200MS1†	IN5200FS1†
Rating				"Reversed Service" Style II Devices			Replacement Interiors	
Amps	Poles and Wires	Receptacle/ Connector Configuration*	Maximum Voltage AC/DC	Receptacle	Plug	Connector	Connector & Receptacle	Plug
30	2P 3W		600/250	HBL330RS2WR	HBL330PS2WR	HBL330CS2WR	IN330MS2	IN330FS2
	3P 4W		600/250	HBL430RS2WR	HBL430PS2WR	HBL430CS2WR	IN430MS2	IN430FS2
60	2P 3W		600/250	HBL360RS2WR	HBL360PS2WR	HBL360CS2WR	IN360MS2	IN360FS2
	3P 4W		600/250	HBL460RS2WR	HBL460PS2WR	HBL460CS2WR	IN460MS2	IN460FS2
100	2P 3W		600/250	HBL3100RS2WR	HBL3100PS2WR	HBL3100CS2WR	IN3100MS2	IN3100FS2
	3P 4W		600/250	HBL4100RS2WR	HBL4100PS2WR	HBL4100CS2WR	IN4100MS2	IN4100FS2
200	2P 3W		600/250	HBL3200RS2WR	HBL3200PS2WR	HBL3200CS2WR	IN3200MS2†	IN3200FS2†
	3P 4W		600/250	HBL4200RS2WR	HBL4200PS2WR	HBL4200CS2WR	IN4200MS2†	IN4200FS2†

Rating				"Reversed Service" Corrosion Resistant Devices			Accessories	
Amps	Poles and Wires	Receptacle/ Connector Configuration*	Maximum Voltage AC/DC	 Receptacle	 Plug	Connector	 Back Boxes	 Angle Adapter
200	4P 5W		600/250	M5200BS1R	M5200CS1R	—	MB2003W MB2004W	AA20045

Note: *CAUTION: To avoid electrical shock, review premises carefully and DO NOT use if Pin and Sleeve configuration (design) is already in a circuit having a rating differing from the rating of this device.

**While in use or with cover closed.

†Consult factory.

Corrosion resistant cord sets are available on page Y-17 of this catalog.