



Semiconductor Fuses

Large rectifier PSC fuse selection



25 URD 123 TTF 630



9,5 URD 94 PPASF 3800
+ MCR3E 1-5N

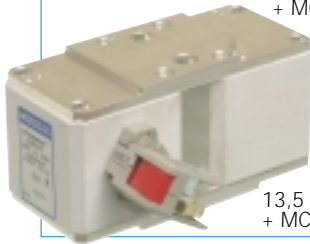

13,5 URD 283 PLAF 1600
+ MCR3E 1-5NBS

Ferraz Shawmut PSC-LR fuse-links provide maximum flexibility in equipment design and ultimate protection for today's power conversion equipment. These square body fuse-links are available in various body sizes with a broad range of ampere ratings allowing the greatest flexibility in equipment design.

The Ferraz Shawmut PSC-LR fuse range has been engineered to provide state of the art protection for high power semiconductors such as diodes, thyristors, GTOs, IGBTs and IGBTs.

They have pure silver fuse elements embedded in solidified sand which provides optimized I²t and high interrupting rating. All contact surfaces are plated and all hardware non-magnetic.

All fuses are standard with a low voltage blown fuse indicator. This indicator can operate a microswitch which is easily mounted directly onto the fuse in service.



13,5 URD 294 TDSFF 3400
+ MCR3E 1-5NBS



13 URD 84 TQFPLA 0900

HIGHLIGHTS

- Highly current limiting.
- Isolating fuse
- High breaking capacities
- High capability of selection in case of external fault
- Worldwide acceptance.
- Superior cycling ability.
- High withstanding in rush current and overloads
- Optimized coordination ratio

APPLICATIONS

Protection of large rectifiers, inverters, static transfer switch, AC & DC drives and UPS systems.

Ratings

AC: up to 10 000A
500 V - 3 800V
100 - 240 kA IR
DC: Consult Factory

Approvals

AC: Tested to IEC 269.4

Features/Benefits

Customized terminals available under request

Wide range of mounting styles

Broad range of ampere ratings in each body size for design flexibility

IEC 269-4 compliance for fuses for worldwide semiconductor applications



Semiconductor Fuses

PSC - LR range - Size 83

700 - 1500 V
4800 - 630 A

Size	Ratings (A)	Voltage (V)	Pre-Arcing I ² t @ 1ms	Total I ² t @ Un	I @ 10ms (A)	Power losses (W)		Breaking capacities (kA)
	I _n	U _n	I ² t _p (kA ² s)	I ² t (kA ² s)		0,8I _n	I _n	
	630	1500	89	635	5400	60	120	173
	725	1500	139	990	6800	73	145	173
	800	1500	186	1330	8000	79	157	173
	850	1500	223	1590	8500	85	170	173
	900	1300	235	1700	8800	68	135	148
	950	1300	355	2600	11000	83	165	148
83	1000	1250	385	2650	12000	85	170	115
end contacts	1050	1250	440	3020	12500	88	175	112
	1100	1200	530	3450	13500	88	175	115
	1250	1150	630	3950	15000	105	210	220
	1400	1100	860	4950	17000	110	220	115
	1550	950	1270	6020	21000	123	245	115
	1800	900	1755	7900	24500	130	260	235
	2000	850	2100	8900	26500	140	280	235
	2200	850	2750	11660	31000	150	300	235
	2400	750	3950	14700	37000	155	310	212
	900	1450	172	1170	7470	63	125	158
	1100	1450	300	3000	9900	93	185	158
	1250	1350	356	2225	10800	120	240	115
	1450	1350	556	3475	13600	145	290	115
	1600	1350	744	4700	16000	158	315	115
	1700	1350	892	5630	17000	170	340	115
2x83	1800	1300	940	6800	17600	135	270	175
double body	1900	1300	1420	10400	22000	165	330	175
press pack	2000	1150	1540	9600	24000	170	340	115
or end contacts	2100	1150	1760	11000	25000	175	350	111
	2200	1100	2120	12400	27000	175	350	220
	2500	1100	2520	14500	30000	210	420	220
	2800	1000	3440	17200	34000	220	440	220
	3100	850	5080	21500	42000	245	490	220
	3600	850	7020	29850	49000	260	520	235
	4000	800	8400	33600	53000	280	560	212
	4400	800	11000	43900	62000	300	600	212
	4800	700	15800	54300	74000	310	620	230

Semiconductor Fuses

PSC - LR range - 83

Size	Catalog Number	Weight (g)	Packaging
	15 URD 83 TTF 0630		
	15 URD 83 TTF 0725		
	15 URD 83 TTF 0800		
	15 URD 83 TTF 0850		
	13 URD 83 TTF 0900		
	13 URD 83 TTF 0950		
	12,5 URD 83 TTF 1000		
	12,5 URD 83 TTF 1050		
83	12 URD 83 TTF 1100		
end contacts	11,5 URD 83 TTF 1250	1600	1
	11 URD 83 TTF 1400		
	9,5 URD 83 TTF 1550		
	9 URD 83 TTF 1800		
	8,5 URD 83 TTF 2000		
	8,5 URD 83 TTF 2200		
	7,5 URD 83 TTF 2400		
	14,5 URD 283 PLAF 0900		
	14,5 URD 283 PLAF 1100		
	12,5 URD 283 PLAF 1350		
	13,5 URD 283 PLAF 1450		
	13,5 URD 283 PLAF 1600		
	13,5 URD 283 PLAF 1700		
2x83*	13 URD 283 PLAF 1800		
double body	13 URD 283 PLAF 1900		
end contacts	11,5 URD 283 PLAF 2000	3350	1
	11,5 URD 283 PLAF 2100		
	11 URD 283 PLAF 2200		
	11 URD 283 PLAF 2500		
	10 URD 283 PLAF 1000		
	8,5 URD 283 PLAF 3100		
	8,5 URD 283 PLAF 3600		
	8 URD 283 PLAF 4000		
	8 URD 283 PLAF 4400		
	7 URD 283 PLAF 4800		

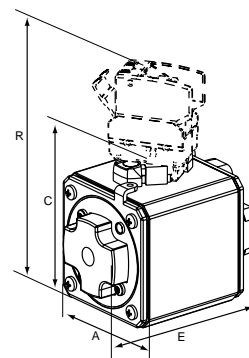



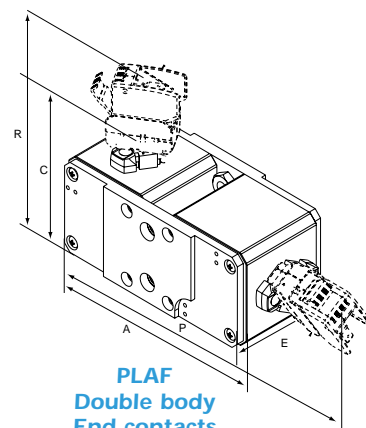



TTF
End contacts



PLAF
Double body
End contacts

* Press pack available on request

Microswitches : MC3E1-5N  - Ref. D310020
 MC3E1-5NBS * - Ref. E310021 Insulation voltage 1250 VAC - DC (data p 21)
 MC3E1-9NBS * - Ref. F310022
 MC3E1-5NET - Ref. L310027
 MCR3E1-5N * - Ref. G310023
 MCR3E1-5NBS * - Ref. P310030
 MCR3E1-9NBS * - Ref. H310024 Insulation voltage 2200 VAC - DC (data p 21)
 MCR3E1-5NET - Ref. Q310031

Threaded studs and microswitches ordered separately

Size	A	C ⁽¹⁾	D	E ^{+1,7}	d	G ^{+0,1}	P	R
83 TTF	73	88	-	96,5	M12	9	-	135
	2.9"	3.5"		3.8"		0.35"		5.31
283 PLAF	180	88	-	84	M 10	15	147	62
	7.9"	3.5"		3.31"		19.32"	5.79"	2.44"

Dimension in mm and inches

See studs p. 22

See mounting torque and clamping force information p 23

(1) Trip indicator extended

(*) Pending