

Threaded Products and Hardware

A100 Regular Spring Nut*

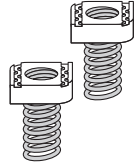

Available in stainless steel 316. Nut is square over 1/2 in. size. For all A and C Series channel and inserts.

Cat. No.	Size (in.)	Wt./C lb.
A100-1/4EGC	1/4	8
A100-5/16EGC*	5/16	9
A100-3/8EGC	3/8	10
A100-1/2EGC	1/2	12
A100-5/8EGC	5/8	19
A100-3/4	3/4	19
A100-7/8	7/8	18

* Not available in stainless steel.

B100 Short Spring Nut*

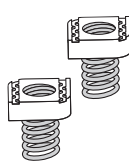

Available in Stainless Steel 316. For all B and D Series channel and inserts.

Cat. No.	Size (in.)	Wt./C lb.
B100-1/4EGC	1/4	7
B100-5/16EGC	5/16	8
B100-3/8EGC	3/8	9
B100-1/2EGC	1/2	9

H100 Long Spring Nut*

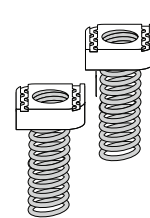

For all E and H Series channel and inserts.

Cat. No.	Size (in.)	Wt./C lb.
H100-3/8EGC	3/8	10
H100-1/2EGC	1/2	14

AB100 Springless Nut 1/4 in. thick

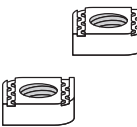

For use with all channels. Nut is square over 1/2 in. size.

Cat. No.	Size (in.)	Wt./C lb.
AB100-1/4EGC	1/4	7
AB100-5/16EGC	5/16	8
AB100-3/8EGC	3/8	9
AB100-1/2EG	1/2	9
AB100-5/8EG	5/8	10
AB100-3/4EG	3/4	10

AC100 Springless Nut Heavy duty 3/8 in. thick

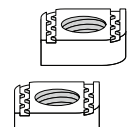

For all A, C, E and H Series channel and inserts. Nut is square over 1/2 in. size.

Cat. No.	Size (in.)	Wt./C lb.
AC100-3/8EGC	3/8	9
AC100-1/2EGC	1/2	11
AC100-5/8EGC	5/8	18
AC100-3/4EGC	3/4	18

813EG Springless Nut Light Duty



For use with all channels.

Cat. No.	Size (in.)	Wt./C lb.
813EG	1/4	5

A182 to A185 Regular Spring Stud Nut*

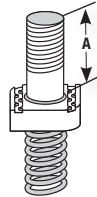

For all A and C Series channels.

Cat. No.	Bolt Dia (in.)	Length A (in.)	Wt./C lb.
A182-1/4x100EG	1/4	1	10
A182-1/4x125EG	1/4	1-1/4	15
A184-3/8x100EG	3/8	1	10
A184-3/8x125EG	3/8	1-1/4	15
A185-1/2x100EG	1/2	1	10
A185-1/2x125EG	1/2	1-1/4	15

A177 to A179 Springless Stud Nut

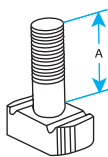

For use with all channels.

Cat. No.	Bolt Dia (in.)	Length A (in.)	Wt./C lb.
A177-1/4x100EG	1/4	1	8
A177-1/4x125EG	1/4	1-1/4	10
A179-3/8x100EG	3/8	1	13
A179-3/8x125EG	3/8	1-1/4	13.5

812 Stud Nut

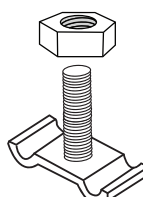

For attaching fixture to channel slot down or to channel slot up knockouts. Specify length. Hex nut included.

Cat. No.	For Channel	Wt./C lb.
812-1EG	1/4 x 1	6

E145 Standard Hex Nut

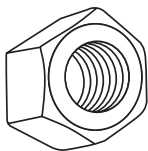

Cat. No.	Size (in.)	Wt./C lb.
E145-1/4EGC	1/4	.72
E145-3/8EGC	3/8	1.60
E145-1/2EGC	1/2	2.78
E145-5/8EG	5/8	6.92
E145-3/4EGC	3/4	12.70
E145-7/8EGC	7/8	19.00
E145-1EGC	1	28.00

UCN Universal Nylon Cone Nut



GoldGalv® only
For all 1-5/8 in. and 1-1/2 in. channels.
May be used with ALL Strut Depths.
Can be used for A100 Series, B100 Series and AB100 Series.

Cat. No.	Size (in.)	Wt./C lb.
UCN-1/4	1/4	8
UCN-3/8	3/8	10
UCN-1/2	1/2	12

AB102 Unhardened Square Nut

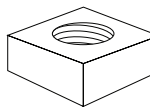

Cat. No.	Size (in.)	Wt./C lb.
AB102-1/4	1/4	13
AB102-3/8	3/8	14
AB102-1/2	1/2	14
AB102-5/8	5/8	12
AB102-3/4	3/4	11
AB102-7/8	7/8	10

ES145 Swivel Nut and Jam Nut Combinations

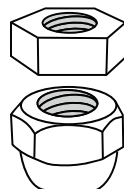

Cat. No.	Size (in.)	Wt./C lb.
ES145-3/8	3/8	5.5
ES145-1/2	1/2	6.0

E146 Standard Square Nut

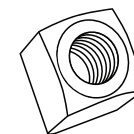

Cat. No.	Size (in.)	Wt./C lb.
E146-1/4EG	1/4	.93
E146-5/16EG	5/16	1.60
E146-3/8EGC	3/8	2.65
E146-1/2EG	1/2	5.83
E146-5/8EG	5/8	10.80

*Supplied with a plastic sleeve over the spring portion to prevent tangling inside the carton.

Surface Raceway and Lighting Systems

Fixture Fittings

Pre-Galvanized Steel Closure Strip

AB844PGC

AB844PGCWH White Epoxy Powder Coated

Plastic Closure Strip

AB844PC Color : Gold

AB844PCGY Color : Grey

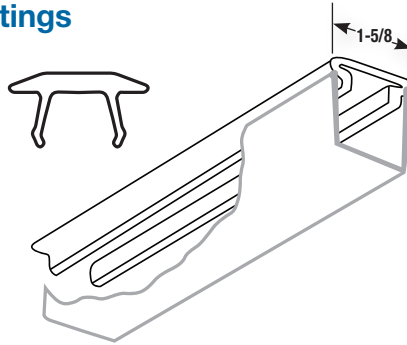

- When used as a raceway, channel is normally installed with the slot up. After wiring has been completed the closure strip is installed.
- For all channels.
- Standard length: 10 ft.



Stainless Steel Closure Strip

AB844SS6CS

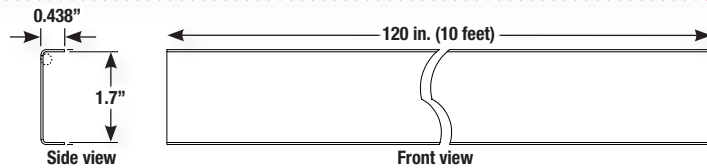

Note:
Strapping not included.

AB803 Cast Conduit Connector

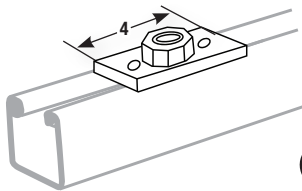

To connect 1/2 in. or 3/4 in. conduit to raceway channel. Furnished complete with stud nuts and hex nuts. Part has removable bushing to increase size from 1/2 in. to 3/4 in.

Wt./C 60 lb.

AB815 Swing Connector

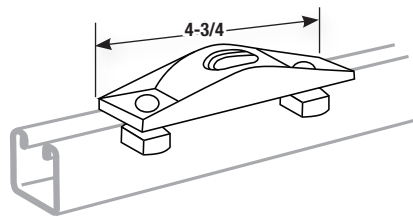

Nuts and bolts to clamp to channel is included. For 1/2 in. or 3/4 in. conduit.

Wt./C 95 lb.

AB885 15° Swivel

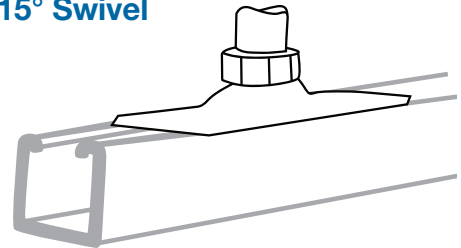

Nuts and bolts to clamp to channel included. For 1/2 in. or 3/4 in. conduit.

Wt./C 25 lb.

AB867 Spacer

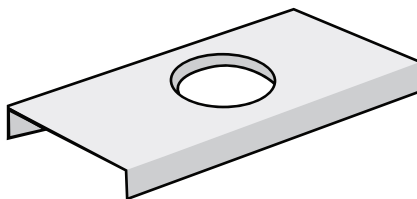

For use with AB866 wiring stud nuts.

Wt./C 24 lb.

AB866 Wiring Stud Nut

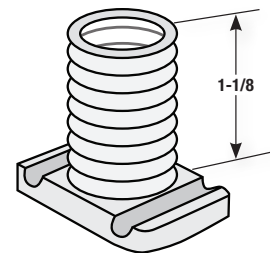

1/2 in. Pipe thread
Wt./C 21 lb.

811 Stud Nut

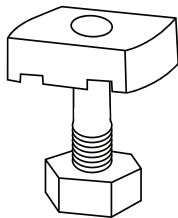

812 Stud Nut

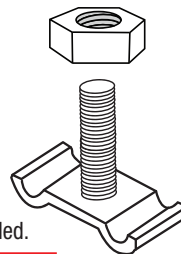

For attaching fixture to slot down channel or to slot up knockouts. Specify length. Hex nut included.

Cat. No.	For Channel	Wt./C lb.
811-1STR	1/4 x 1	8
811-2STR	1/4 x 1-1/4	9

Cat. No.	For Channel	Wt./C lb.
812-1EG	1/4 x 1	6

AB868 Fiber Retainer for Cables Until Closure Strip is Installed

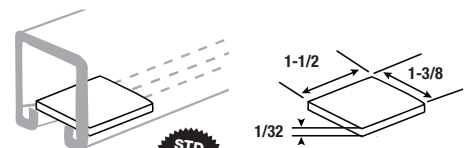

Wt./C 3 lb.

