

MEDIUM BI-PIN STRAIGHT-IN LAMPHOLDERS

Low Profile • G13 Base



LINEAR FLUORESCENT

Turn-Type Lampholders for T-8 and T-12 Lamps

Low Profile. Molded, white thermosetting urea. Quickwire pressure terminals accept stranded No. 18 gauge, twisted and overtinned, or No. 18 solid or solder-dipped leads stripped 3/8". Knife-edge contacts. Unplated contacts are standard. Multiple terminal slots permit double connections at each contact.

Recessed wire wells completely enclose conductor, insulating against shorts.

Screws assembled or furnished bulk are #6-32 x 3/8".

Cat. Nos. 13351 & 13353

• 660W-600V • UL Listed E-5833 • CSA Certified LR-5863 • NOM Certified 057



13351

SECTION A

Typical Low-Profile Dimensions

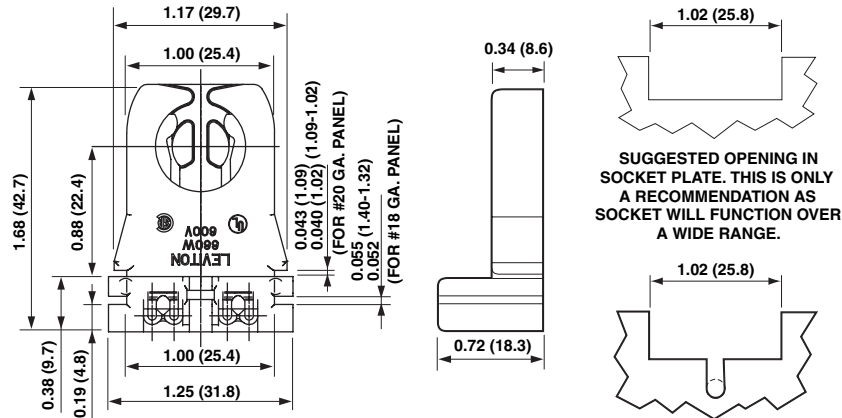

Cat. No. 13351

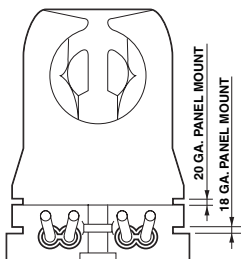

Cat. No. 13351 11/32" thick. Beveled front and individual contact legs for easier wire insertion.

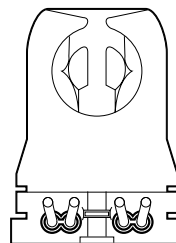

Cat. No. 13351-00N 11/32" thick #20 GA. Panel Mount Captive Nut, screws furnished bulk

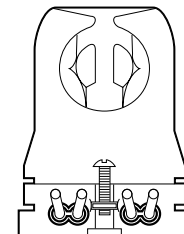

Cat. No. 13351-0NX 11/32" thick #20 GA. Panel Mount Captive Nut & Screw

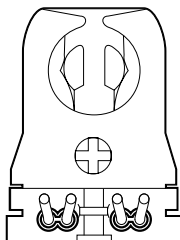

Cat. No. 13353 11/32" thick #18 GA. Panel Mount

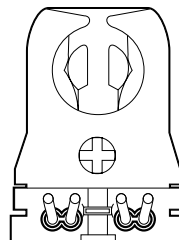

Cat. No. 13353-00N 11/32" thick #18 GA. Panel Mount Captive Nut, screws furnished bulk

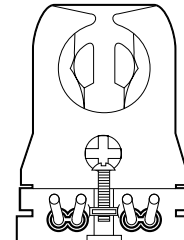

Cat. No. 13353-0NX 11/32" thick #18 GA. Panel Mount Captive Nut & Screw