

Dimensions Inches (mm)



Style	1-Gang	2-Gang	3-Gang
	 PFBRG1*	 PFBRG2	 PFBRG3
Min. Depth of Pour	3.00" (76.2)	3.00" (76.2)	3.00" (76.2)
Adjustability	Fully	Fully	Fully
Cubic Inch (cm3) Capacity Per Gang	14.3 cu. in. (234.3 cm3)	14.3 cu. in. (234.3 cm3)	14.3 cu. in. (234.3 cm3)
Dimensions – A	6.00" (152.4)	6.00" (152.4)	6.00" (152.4)
Dimensions – B	3.60" (91.4)	6.82" (173.2)	10.04" (255.0)
Dimensions – C	5.42" (137.7)	5.42" (137.7)	5.42" (137.7)
Dimensions – D	6.90" (175.3)	6.90" (175.3)	6.90" (175.3)
Dimensions – E	5.44" (138.2)	8.66" (220.0)	11.87" (301.5)
Hubs	(4) 1¼"	(6) 1¼"	(8) 1¼"
Reducers	(4) 1" to ¾" and (4) 1¼" to 1"	(6) 1" to ¾" and (6) 1¼" to 1"	(8) 1" to ¾" and (8) 1¼" to 1"
Concrete Cover Included	✓	✓	✓
Closure Plugs Included	✓	✓	✓
Removable LV Barrier	–	✓	✓

Note: UL File Number E92074.

*Suitable for single service applications only.

Flush Rectangular Metal Covers and Flanges

Required Components for Carpet and Tile Applications

Adapter Collar (One required per gang)	Adapter Frame with Grounding Lug (One required per gang) Dim. 4.36" x 3.20"
Gray PFBRAC 	Brass S5017G  Aluminum SA5017G

Flush Rectangular Metal Covers and Flanges

Required Components for Carpet and Tile Applications

Adapter Collar (One required per gang)
Gray PFBRAC 

Carpet Flanges (Not Required for Tile Applications)

Tapered Flange	1-Gang	2-Gang	3-Gang
Number of Gangs	1-Gang	2-Gang	3-Gang
Dimensions	6.00" x 4.85"	6.00" x 8.13"	6.00" x 11.34"
Brass	SB3083	SB3084	SB3085
Aluminum	SA3083	SA3084	SA3085









Rectangular Flanges (Required)

1-Gang	2-Gang	3-Gang	
Dimensions	6.00" x 4.85"	6.00" x 8.13"	6.00" x 11.34"
Brass	SB3083W	SB3084W	SB3085W
Aluminum	SA3083W	SA3084W	SA3085W



Covers – One Required per Gang

Brass	S3825	S3625	S3826	S2425	S2625	S2825	S3813
Aluminum	SA3825	SA3625	SA3826	SA2425	SA2625	–	SA3813
Dimensions	4.15" x 2.99"						
							
	Duplex Flap	Duplex Screw	Style Line® Decorator Opening	2½" x ¾" Combination	2½" x 1" Combination	2½" Single Receptacle	Blank

Dimensions in Inches (mm)



Experiencing a problem? Let Hubbell accessories help solve it. Hubbell stacking (adjustable) collars are the answer if the box is set too low. Need a replacement? Choose from a full line of replacement covers and fittings. Hubbell accessories also help you with the protection you need for plugs and receptacles.

Problem Solvers and Replacement Components Stacking (Adjustable) Collars and Frames

Designed to be used if floor box is set too low beneath the floor surface or the adjustable collar and/or adapter on the box is damaged.

If the box number is...	Extension Value	Use Collar Number
B2429, B2427, B2436 or B2437	.81" (20.5)	C2400*
B2503, B2506	1.06" (26.9)	C2504*
B2529, B2536, B2527 or B2537	1.06" (26.9)	C2500*
B4233	1.03" (26.2)	C4200*
B4333	1.03" (26.2)	C4300*

Note: *Only available as sets (collars and adapters). In cases where the adapter on the floor box is not damaged, and only stacking is required, discard the adapter and use only the collar. The adjustable collars listed above can be stacked as required to reach the floor surface. Longer screws will be required if more than one collar is stacked (screws not provided). These screws are commercially available. Flat head #12-24 UNC machine screw x (approx. length). Minor Upward Adjustments: Round or Rectangular cover frames (trim rings) may be stacked if the floor box is only slightly recessed below the floor surface.

Replacement Components for Floor Box Covers and Fittings

Box Type	Dimension	Extension Value	Catalog Number	
			Brass	Aluminum
Round	4.19" (106.4) diameter	.31" (7.9)	S5016	SA5016
Rectangular	3.19" (81.0) x 4.38" (111.2)	.31" (7.9)	S5017A	SA5017A
Rectangular, grounding	3.19" (81.0) x 4.38" (111.2)	.31" (7.9)	S5017G	SA5017G

Crown Plugs

Description	Used in the following covers	Catalog Number	
		Brass	Aluminum
¾" thread size.	S2525, SA2525, S881, S2555, S2530, S2425, SA2425, SF2525	S5012	SA5012
1" thread size.	S2725, SA2725, S2755, S2730, S2625, SA2625, SF2725	S5013	SA5013

Flush Cap Rings

Description	Used in the following covers	Catalog Number	
		Brass	Aluminum
2½" threaded plug with ¾" thread size opening.	S2525, SA2525, S881, S2555, S2530, S2425, SA2425, SF2525	S5010	SA5010
2½" threaded plug with 1" thread size opening.	S2725, SA2725, S2755, S2730, S2625, SA2625, SF2725	S5025	SA5025

Flush Plugs

Description	Used in the following covers	Catalog Number	
		Brass	Aluminum
¾" I.P.S. thread size.	F1339, F1340	S5002	-
1" I.P.S. thread size.	F1539	S5003	-
1½" fine thread size.	S3725, SA3725, S3625, SA3625	S5007	SA5007
2½" fine thread size.	S2925, SA2925, S88, S2930, S2955, SF2925, S2825	S5020	SA5020
2¾" fine thread size.	S3525, S3425	S5030	-

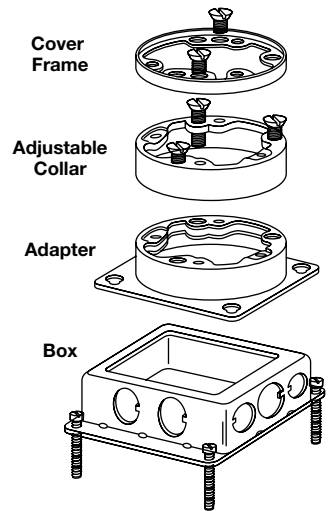

Replacement Adjustable Collar



Replacement Cover Frames



Crown Plugs



Flush Cap Rings



Flush Plugs



Dimensions in Inches (mm)