

Dimensions Inches (mm)

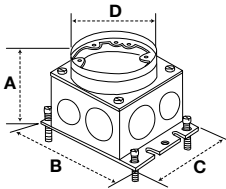



Style	Cast Iron						Stamped Steel	
								
Collar Material: Brass Aluminum	B2536 BA2536	B253641 BA253641	B2503 BA2503	B2506 BA2506	B2506415 BA2506415	B2537 BA2537	B2527 BA2527	B2529 BA2529
Min. Depth of Pour	3.25" (82.6)	3.75" (95.3)	4.75" (120.7)	3.00" (76.2)	4.00" (101.6)	3.00" (76.2)		
Adjustability	Fully	Fully	Fully	Fully	Fully	Fully	Fully	Fully
Before Pour External Height Adjustment	1.25" (31.8)	-	-	-	-	1.25" (31.8)	1.25" (31.8)	
After Pour Internal Height Adjustment	.38" (9.5)	.63" (15.9)	.63" (15.9)	.38" (9.5)	.38" (9.5)	.38" (9.5)	.38" (9.5)	
Cubic Inch (cm3) Capacity	33.0 cu. in. (540.7 cm3)	36.0 cu. in. (590.0 cm3)	50.8 cu. in. (832.5 cm3)	30.0 cu. in. (491.6 cm3)	54.0 cu. in. (884.9 cm3)	37.3 cu. in. (611.2 cm3)		
Dimensions – A	3.05" (77.5)	3.75" (95.3)	4.75" (120.7)	2.87" (72.9)	3.88" (98.6)	2.91" (73.9)		
Dimensions – B	4.84" (122.9)	5.00" (127.0)	5.00" (127.0)	4.84" (122.9)	6.00" (152.4)	6.00" (152.4)		
Dimensions – C	4.84" (122.9)	4.63" (117.6)	4.66" (118.4)	4.84" (122.9)	4.81" (122.2)	4.81" (122.2)		
Dimensions – D	4.19" (106.4)	4.19" (106.4)	4.19" (106.4)	4.19" (106.4)	4.19" (106.4)	4.19" (106.4)		
Threaded Access Holes	(4) 3/4" (4) 1"	(4) 3/4"	(4) 1 1/4"	(4) 1 1/2"	(4) 3/4"	-	-	-
Knockouts – Sides	-	-	-	-	-	(1) 1" & (1) 3/4"	(2) 1/2" & (1) 3/4"	
Knockouts – Ends	-	-	-	-	-	(1) 1 1/4" & (1) 1/2"	(1) 1/2" & (1) 3/4"	
Knockouts – Bottom	-	-	-	-	-	(3) 1/2" & (2) 3/4"	(3) 1/2" & (2) 3/4"	
Concrete Cover Included	✓	✓	✓	✓	✓	✓	✓	✓
Closure Plugs Included	✓	✓	✓	✓	✓	-	-	-

Note: UL File Number E31999.
 CSA File Number LR18416.
 Suitable for single service applications only.

Single Service Covers

Material	S3925 SA3925	S3725 SA3725	S2525 SA2525	S2725 SA2725	S2925 SA2925	S3525 -	S3325 -
Brass Aluminum 3.88 in. Dia.							
	Duplex Flap	Duplex Screw	2 1/8" x 3/4" Combination	2 1/8" x 1" Combination	2 1/8" Single Receptacle	2 3/8" Single Receptacle	2 1/8" Single Receptacle (Terrazzo Floor)

Carpet Flanges

5.25 in. Dia.	S3182	SA3182	S3079	6.25 in. Dia.	S3082	SA3082
						
	Brass	Brushed Aluminum	Clear Polycarbonate		Brass	Brushed Aluminum

One Piece Brass Cover and Carpet Flange

6.25 in. Dia.	SF3925	SF2525	SF2725	SF2925
				
	Duplex Flap	2 1/8" x 3/4" Combination	2 1/8" x 1" Combination	2 1/8" Single Receptacle



Experiencing a problem? Let Hubbell accessories help solve it. Hubbell stacking (adjustable) collars are the answer if the box is set too low. Need a replacement? Choose from a full line of replacement covers and fittings. Hubbell accessories also help you with the protection you need for plugs and receptacles.

Problem Solvers and Replacement Components Stacking (Adjustable) Collars and Frames

Designed to be used if floor box is set too low beneath the floor surface or the adjustable collar and/or adapter on the box is damaged.

If the box number is...	Extension Value	Use Collar Number
B2429, B2427, B2436 or B2437	.81" (20.5)	C2400*
B2503, B2506	1.06" (26.9)	C2504*
B2529, B2536, B2527 or B2537	1.06" (26.9)	C2500*
B4233	1.03" (26.2)	C4200*
B4333	1.03" (26.2)	C4300*

Note: *Only available as sets (collars and adapters). In cases where the adapter on the floor box is not damaged, and only stacking is required, discard the adapter and use only the collar. The adjustable collars listed above can be stacked as required to reach the floor surface. Longer screws will be required if more than one collar is stacked (screws not provided). These screws are commercially available. Flat head #12-24 UNC machine screw x (approx. length). Minor Upward Adjustments: Round or Rectangular cover frames (trim rings) may be stacked if the floor box is only slightly recessed below the floor surface.

Replacement Components for Floor Box Covers and Fittings

Box Type	Dimension	Extension Value	Catalog Number	
			Brass	Aluminum
Round	4.19" (106.4) diameter	.31" (7.9)	S5016	SA5016
Rectangular	3.19" (81.0) x 4.38" (111.2)	.31" (7.9)	S5017A	SA5017A
Rectangular, grounding	3.19" (81.0) x 4.38" (111.2)	.31" (7.9)	S5017G	SA5017G

Crown Plugs

Description	Used in the following covers	Catalog Number	
		Brass	Aluminum
¾" thread size.	S2525, SA2525, S881, S2555, S2530, S2425, SA2425, SF2525	S5012	SA5012
1" thread size.	S2725, SA2725, S2755, S2730, S2625, SA2625, SF2725	S5013	SA5013

Flush Cap Rings

Description	Used in the following covers	Catalog Number	
		Brass	Aluminum
2½" threaded plug with ¾" thread size opening.	S2525, SA2525, S881, S2555, S2530, S2425, SA2425, SF2525	S5010	SA5010
2½" threaded plug with 1" thread size opening.	S2725, SA2725, S2755, S2730, S2625, SA2625, SF2725	S5025	SA5025

Flush Plugs

Description	Used in the following covers	Catalog Number	
		Brass	Aluminum
¾" I.P.S. thread size.	F1339, F1340	S5002	-
1" I.P.S. thread size.	F1539	S5003	-
1½" fine thread size.	S3725, SA3725, S3625, SA3625	S5007	SA5007
2½" fine thread size.	S2925, SA2925, S88, S2930, S2955, SF2925, S2825	S5020	SA5020
2¾" fine thread size.	S3525, S3425	S5030	-

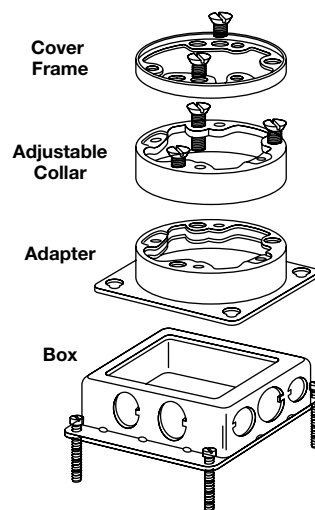

Replacement Adjustable Collar



Replacement Cover Frames



Crown Plugs



Flush Cap Rings



Flush Plugs



Dimensions in Inches (mm)