

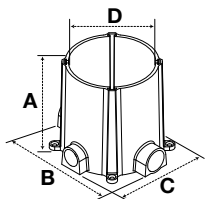



Floor Boxes Flush Round Single or Multi-Service Non-Metallic Concrete Floor Box

Dimensions Inches (mm)

	
Min. Depth of Pour	3.00" (76.2)
Capacity	100 cubic inches prior to cutting level to floor (19.5 cubic inches per inch of depth).
Dimensions – A	6.00" (152.4)
Dimensions – B	7.08" (179.8)
Dimensions – C	6.69" (169.9)
Dimensions – D	5.38" (136.5)
Hubs	(2) 1.0" and (2) ¾" conduit hubs
Concrete Cover Included	✓
Closure/Reducer Plugs	(2) 1" plugs close off 1" hubs or reduce 1" to ¾" (2) ¾" plugs close off ¾" hubs or reduce ¾" to ½"

Note: UL File Number E92074. CSA File Number LR18416.

Description	Catalog Number
Adapter Required for all applications.	 PFBA1A
Low Voltage Divider Required for use with catalog number PFB1 when used in multi-service applications. Accepts Hubbell standard duplex receptacles or 15A Twist-Lock® duplex receptacles (HBL4700 series).	 PFBT1A
"Y" Adapter ¾ in. "Y" adapter to feed parallel runs of ¾ in. conduit.	 PFBYA1

Flush Round Covers and Flanges

Multi-Service Cover and Flange Assemblies

Includes floor box cover with duplex flaps, (2) ½ in. dia. low voltage feed through holes and matching carpet flange. 6.25 in. Diameter

SF39253A



Brass

PFBCBRA



Brown Non-Metallic

PFBCBLA



Black Non-Metallic

PFBCGYA



Gray Non-Metallic

PFBCIA



Ivory Non-Metallic

Single Service Covers

Brass
Aluminum
3.88 in. Dia.

S3925
SA3925



Duplex Flap

S3725
SA3725



Duplex Screw

S2525
SA2525



2 1/8" x ¾"
Combination

S2725
SA2725



2 1/8" x 1"
Combination

S2925
SA2925



2 1/8" Single Receptacle

S3525
—



2 3/8" Single Receptacle

S3325
—



2 1/8" Single Receptacle (Terrazzo Floor)

Metal Carpet Flange

Use with single service covers for carpet applications. 6.25 in. Diameter

S3082



Brass

SA3082



Brushed Aluminum

Adapter Ring

Use with single service covers for tile applications.

S5016



Brass

SA5016



Aluminum

Furniture Feed Plate

Unpainted plate with 1 in. threaded opening.

PFBP1



Steel

One Piece Brass Cover and Carpet Flange

6.25 in. Dia.

SF3925



Duplex Flap

SF2525



2 1/8" x ¾"
Combination

SF2725



2 1/8" x 1"
Combination







SF2925

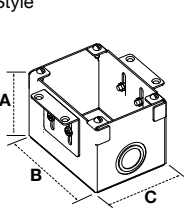
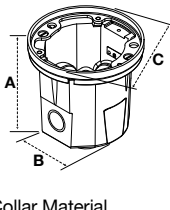

2 1/8" Single Receptacle



Note: Adapter ring S5016 is required for mounting SF series covers onto PFBA1A.

Dimensions Inches (mm)

Style	  Collar Material Brass	Rectangular Stamped Steel			Round Cast Iron	
		1-Gang	2-Gang	3-Gang	1-Gang	1-Gang
		 B2481*	 B2482	 B2483	 B2588*	 B2588275*
Adjustability		Semi	Semi	Semi	Non	Non
Cubic Inch (cm3) Capacity Per Gang		42.0 cu. in. (658.3 cm3)	42.5 cu. in. (696.5 cm3)	42.5 cu. in. (696.5 cm3)	18.5 cu. in. (303.2 cm3)	18.5 cu. in. (303.2 cm3)
Dimensions – A		3.13" (79.5)	3.13" (79.5)	3.13" (79.5)	3.65" (92.7)	3.65" (92.7)
Dimensions – B		4.50" (114.3)	4.50" (114.3)	4.50" (114.3)	3.22" (81.8)	3.22" (81.8)
Dimensions – C		3.20" (81.3)	6.42" (163.1)	9.64" (244.9)	4.09" (103.9)	4.09" (103.9)
Threaded Access Holes		–	–	–	Bottom (2) 1/2"	Sides (2) 3/4" Bottom (2) 1/2"
Knockouts – Sides		(1) 1/2", 3/4", 1"	(2) 1/2", 3/4", 1"	(3) 1/2", 3/4", 1"	–	–
Knockouts – Ends		–	–	–	–	–
Knockouts – Bottom		(1) 1/2" - 1 1/4"	(2) 1/2" - 1 1/4"	(3) 1/2" - 1 1/4"	–	–
Debris Cover Included		✓	✓	✓	–	–
Closure Plugs Included		–	–	–	✓	✓
Removable LV Barrier		–	✓	✓	–	–

Note: UL File Number E31999. CSA File Number LR18416.
*Suitable for single service applications only.



Rectangular Flanges (Required)

	SB3083W	SB3084W	SB3085W
Brass	SA3083W	SA3084W	SA3085W
Aluminum			
			
No. of Gangs	1-Gang	2-Gang	3-Gang
Dimensions	6.00" x 4.85"	6.00" x 8.13"	6.00" x 11.34"



Round Flanges

S3182	S3082
SA3182	SA3082
	
5.25" Dia.	6.25" Dia.

Round Covers (3.88" Dia.)

S3925	S3725	S2525
SA3925	SA3725	SA2525
		
Duplex Flap	Duplex Screw	2 1/2" x 3/4" Comb.



Covers – One Required per Gang

	S3825	S3625	S3826	S2425
Brass	SA3825	SA3625	SA3826	SA2425
Aluminum				
Dimensions 4.15" x 2.99"				
	Duplex Flap	Duplex Screw	Style Line® Decorator Opening	2 1/2" x 3/4" Combination
	S2625	S2825	S3425	S3813
Brass	SA2625	–	–	SA3813
Aluminum				
Dimensions 4.15" x 2.99"				
	2 1/2" x 1" Combination	2 1/2" Single Receptacle	2 3/8" Single Receptacle	Blank

Round Covers























	S2725	S2925	S3525	S3325
Brass	SA2725	SA2925	–	–
Aluminum				
3.88" Dia.				
	2 1/2" x 1" Comb.	2 1/2" Single Receptacle	2 3/8" Single Receptacle	2 1/2" Single Rec. (Terrazzo Floor)

One Piece Brass Cover and Carpet Flange

	SF3925	SF2525	SF2725	SF2925
Brass				
6.25" Dia.				
	Duplex Flap	2 1/2" x 3/4" Combination	2 1/2" x 1" Combination	2 1/2" Single Receptacle

Dimensions in Inches (mm)

Floor Boxes Floor Box Cover to Receptacle Compatibility Chart

Cover Style		Terazzo (2 1/8")	2 3/8"	2 1/2"	Duplex Flap	Duplex Plug	Style Line®
Round		S3325 	S3525 	S(A)2925  S(A)2725  S(A)2525 	S(A)3925 	S(A)3725 	
Rectangular			S3425 	S2825  S(A)2625  S(A)2425 	S(A)3825 	S(A)3625 	S(A)3826 
Rating	NEMA Config.						
2P, 3W 15A, 125V	5-15R 	HBL5251 HBL5261 IG5261	HBL5251 HBL5261 IG5261	HBL5251 HBL5261 IG5261	5252AB 5262B CR5252IG HBL5252 HBL5262 IG5262	5252AB 5262B CR5252IG HBL5252 HBL5262 IG5262	HBL2152 IG2152 GF15LA HBL5260SA HBL5262SA
2P, 3W 15A, 125V	L5-15R 	HBL4710 IG4710	HBL4710 IG4710	HBL4710 IG4710	HBL4700 IG4700A HBL4792 HBL4794 HBL4795	HBL4700 IG4700A HBL4792 HBL4794 HBL4795	
2P, 3W 15A, 250V	6-15R 	HBL5661 IG5661	HBL5661 IG5661	HBL5661 IG5661	HBL5652 HBL5662 IG5662	HBL5652 HBL5662 IG5662	
2P, 3W 15A, 250V	L6-15R 	HBL4560 IG4560	HBL4560 IG4560	HBL4560 IG4560	HBL4550 IG4550A	HBL4550 IG4550A	
2P, 3W 15A, 277V	7-15R 				HBL5302	HBL5302	
2P, 3W 15A, 277V	L7-15R 	HBL4760	HBL4760	HBL4760	HBL4750	HBL4750	
2P, 3W 20A, 125V	5-20R 	HBL5361 IG5361	HBL5361 IG5361	HBL5361 IG5361	5352AB 5362B CR5352IG HBL5352 HBL5362 IG5362	5352AB 5362B CR5352IG HBL5352 HBL5362 IG5362	HBL2162 IG2162 GF20LA HBL5360SA HBL5362SA
2P, 3W 20A, 125V	5-20R 				HBL5392	HBL5392	
2P, 3W 20A, 125V	L5-20R 	HBL2310 IG2310	HBL2310 IG2310	HBL2310 IG2310			
2P, 3W 20A, 250V	6-20R 	HBL5461 IG5461	HBL5461 IG5461	HBL5461 IG5461	HBL5462 IG5462	HBL5462 IG5462	
2P, 3W 20A, 250V	L6-20R 	HBL2320 IG2320	HBL2320 IG2320	HBL2320 IG2320			
2P, 3W 30A, 125V	L5-30R 	HBL2610 IG2610	HBL2610 IG2610	HBL2610 IG2610			
2P, 3W 30A, 250V	L6-30R 	HBL2620 IG2620	HBL2620 IG2620	HBL2620 IG2620			
3P, 4W, 20A 125/250V	14-20R 	HBL8410	HBL8410	HBL8410			
	L14-20R 	HBL2410 IG2410	HBL2410 IG2410	HBL2410 IG2410			
3P, 4W, 20A 3Ø 250V	15-20R 	HBL8420	HBL8420	HBL8420			
	L15-20R 	HBL2420 IG2420	HBL2420 IG2420	HBL2420 IG2420			
3P, 4W, 30A 125/250V	L14-30R 	HBL2710 IG2710	HBL2710 IG2710	HBL2710 IG2710			
3P, 4W, 30A 3Ø 250V	L15-30R 	HBL2720 IG2720	HBL2720 IG2720	HBL2720 IG2720			
3P, 4W, 30A 3Ø 600V	L17-30R 	HBL2740	HBL2740	HBL2740			
4P, 5W, 20A 3ØY 120/208V	L21-20R 	HBL2510 IG2510	HBL2510 IG2510	HBL2510 IG2510			
4P, 5W, 20A 3ØY 347/600V	L23-20R 	HBL2530	HBL2530	HBL2530			
4P, 5W, 30A 3ØY 120/208V	L21-30R 	HBL2810 IG2810	HBL2810 IG2810	HBL2810 IG2810			
4P, 5W, 30A 3ØY 347/600V	L23-30R 	HBL2830	HBL2830	HBL2830			



Experiencing a problem? Let Hubbell accessories help solve it. Hubbell stacking (adjustable) collars are the answer if the box is set too low. Need a replacement? Choose from a full line of replacement covers and fittings. Hubbell accessories also help you with the protection you need for plugs and receptacles.

Problem Solvers and Replacement Components Stacking (Adjustable) Collars and Frames

Designed to be used if floor box is set too low beneath the floor surface or the adjustable collar and/or adapter on the box is damaged.

If the box number is...	Extension Value	Use Collar Number
B2429, B2427, B2436 or B2437	.81" (20.5)	C2400*
B2503, B2506	1.06" (26.9)	C2504*
B2529, B2536, B2527 or B2537	1.06" (26.9)	C2500*
B4233	1.03" (26.2)	C4200*
B4333	1.03" (26.2)	C4300*

Note: *Only available as sets (collars and adapters). In cases where the adapter on the floor box is not damaged, and only stacking is required, discard the adapter and use only the collar. The adjustable collars listed above can be stacked as required to reach the floor surface. Longer screws will be required if more than one collar is stacked (screws not provided). These screws are commercially available. Flat head #12-24 UNC machine screw x (approx. length). Minor Upward Adjustments: Round or Rectangular cover frames (trim rings) may be stacked if the floor box is only slightly recessed below the floor surface.

Replacement Components for Floor Box Covers and Fittings

Box Type	Dimension	Extension Value	Catalog Number	
			Brass	Aluminum
Round	4.19" (106.4) diameter	.31" (7.9)	S5016	SA5016
Rectangular	3.19" (81.0) x 4.38" (111.2)	.31" (7.9)	S5017A	SA5017A
Rectangular, grounding	3.19" (81.0) x 4.38" (111.2)	.31" (7.9)	S5017G	SA5017G

Crown Plugs

Description	Used in the following covers	Catalog Number	
		Brass	Aluminum
¾" thread size.	S2525, SA2525, S881, S2555, S2530, S2425, SA2425, SF2525	S5012	SA5012
1" thread size.	S2725, SA2725, S2755, S2730, S2625, SA2625, SF2725	S5013	SA5013

Flush Cap Rings

Description	Used in the following covers	Catalog Number	
		Brass	Aluminum
2½" threaded plug with ¾" thread size opening.	S2525, SA2525, S881, S2555, S2530, S2425, SA2425, SF2525	S5010	SA5010
2½" threaded plug with 1" thread size opening.	S2725, SA2725, S2755, S2730, S2625, SA2625, SF2725	S5025	SA5025

Flush Plugs

Description	Used in the following covers	Catalog Number	
		Brass	Aluminum
¾" I.P.S. thread size.	F1339, F1340	S5002	-
1" I.P.S. thread size.	F1539	S5003	-
1½" fine thread size.	S3725, SA3725, S3625, SA3625	S5007	SA5007
2½" fine thread size.	S2925, SA2925, S88, S2930, S2955, SF2925, S2825	S5020	SA5020
2¾" fine thread size.	S3525, S3425	S5030	-

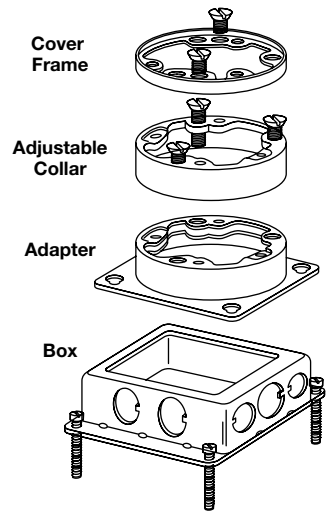

Replacement Adjustable Collar



Replacement Cover Frames



Crown Plugs



Flush Cap Rings



Flush Plugs



Dimensions in Inches (mm)